



Delta ACB

Air Circuit Breakers



ELMEASURE[®]
Possibilities...Infinite



Protect your Electrical systems with the best-in-class ACBs.

When it comes to protecting your electrical system, you need a solution that is reliable, efficient, and advanced. The Delta Air Circuit Breakers (ACB) can be the perfect choice for businesses and industries that demand the best in power distribution and protection. With advanced features such as adjustable trip settings, remote monitoring, compact design and safety features, the Delta ACB offers a range of benefits that ensure superior performance and exceptional protection.

Discover unmatched protection with Delta Air Circuit Breakers

■ Total Selectivity and Coordination

The Delta Air Circuit Breakers offer selectivity and coordination features, allowing for precise fault detection and isolation. This ensures that only the affected circuit trips, minimizing the impact of faults and reducing system downtime. Selective tripping enables critical operations to remain unaffected while isolating the faulty section for efficient troubleshooting and maintenance.

■ Optional BEMS/IoT Connectivity

Optional communication module features enable Delta ACBs to provide real-time data via Modbus/Profibus/wireless Zigbee protocols on the status of the circuit breaker and the electrical system, including current, voltage, power, and energy consumption. This helps operators to monitor and diagnose faults, and take corrective actions before a catastrophic failure occurs.

■ Advanced System Monitoring

Featuring optional power and harmonics measurement, Delta ACB allows for accurate monitoring of power quality and harmonics levels as well as its true terminal temperature. By offering these monitoring capabilities, the circuit breaker enables proactive maintenance, early detection of potential issues, and their optimizations.

■ Highest quality of standards

Compliant to International Standard

- IS/IEC 60947-2 Low Voltage Switchgear and Controlgear, Part 2: Circuit-breakers

■ Advanced Protection Mechanisms

The Delta Air Circuit Breakers go beyond traditional circuit breakers by offering a range of advanced features that provide enhanced protection for your electrical system. With adjustable trip settings, you have the flexibility to customize the response of the circuit breaker to different electrical loads, ensuring optimal protection and preventing unnecessary tripping. The fault protection mechanism detects abnormal conditions such as short circuits and overloads, swiftly interrupting the electrical flow to prevent damage to your equipment. Additionally, the instantaneous trip functions enable quick and precise fault detection and interruption, minimizing the duration of electrical faults and reducing the risk of further damage or hazards. With these advanced features, the Delta ACBs deliver very high level of protection, ensuring the safety and reliability of your electrical system.

■ Superior Safety Assurance

Delta ACB offers enhanced safety and reliability through various mechanisms. The inbuilt anti-pumping feature prevents multiple closures, the arc-chute interlocking mechanism provides improved protection against arc flash incidents and the smart-racking shutter interlock enhances operational safety by de-energizing the breaker before it can be removed, minimizing electrical hazards during maintenance or replacement.

Delta ACB

Key Features/Benefits

- **Wide range of ratings**

With ACBs available from 800A to 6300A in 3 frames and breaking capacities from 50kA to 100kA, for voltage rating upto 800V AC, Delta ACBs offers you with maximum flexibility in choosing the right circuit breaker for the application.

- **Flexible Configurations**

The Delta ACB offers the benefit of versatile configuration options, with both 3 Pole and 4 Pole variants available. Whether you require a manually or electrically operated circuit breaker, or a fixed or draw-out version, the Delta ACB can cater to your specific needs. This flexibility in choice allows for easy adaptation to different electrical system needs, enhancing convenience and ensuring compatibility with your setup.

- **Robust Fault Protection**

The high short-time withstand capacity and $I_{cu}=I_{cs}=I_{cw}$ for 1 second of Delta ACBs ensure exceptional protection and total selectivity. This means that the circuit breaker can withstand high fault currents without compromising its performance, allowing for efficient fault detection and isolation. With total selectivity, the ACB ensures that only the affected circuit trips, minimizing disruptions and downtime while facilitating easy identification and resolution of faults.

- **Repeated Closure Prevention**

The inbuilt electrical and mechanical anti-pumping feature of Delta ACB prevents multiple breaker closures caused by persistent closing commands. This mechanism ensures that the breaker operates as intended, preventing any undesired or accidental repeated closures. By effectively mitigating the risk of multiple closures, the ACB enhances operational safety, protects the integrity of the electrical system, and minimizes the potential for equipment damage or malfunction.

- **Arc-Chute Safety Assurance**

Delta Air circuit breakers are designed with arc-chute interlocking mechanism to prevent the closure of the breaker if the arc-chute is missing or not properly installed. This feature adds an extra layer of protection by ensuring that the breaker can only be closed when the arc-chute is correctly in place. By verifying the proper installation of the arc-chute, it enhances the safety and effectiveness of the ACB, minimizing the risk of arc flash incidents and associated damages.

- **Prevents Unsafe Racking**

The smart-racking shutter interlock is a safety feature of Delta ACB that ensures the breaker is switched off before it can be racked out. This interlocking mechanism provides an added layer of operational safety by preventing the accidental or unauthorized removal of a live breaker. It ensures that the breaker is de-energized and safe to be racked out, minimizing the risk of electrical hazards and protecting personnel during maintenance or replacement procedures.

- **Rapid Modular Customization**

Delta ACB's modular and snap-fit accessories, including under-voltage, shunt, and closing coil, redefine modularity with an impressive time scale of just 5 minutes. This innovative feature allows for swift and effortless customization of the ACB according to specific requirements. By simplifying the installation and integration of accessories, Delta ACBs significantly reduces the time and effort involved in configuring the breaker. This streamlined modularity enhances efficiency, enables rapid adaptability, and promotes seamless customization to meet evolving needs.

FLS Trip units for customized shielding and advanced protection

The FlexiShield FLS ACB trip units provide maximum flexibility and advanced shielding/protection features. Designed with a focus on "Flexibility, Scalability & Customization," these releases offer a diverse range of withdrawable modules, including Modbus, Profibus, Zigbee, Smart Configurator, and Power metering. With the option to start with the basic FLS 3.5 release, users can easily upgrade the protection release to include Power metering and Communication modules in the future, adapting to evolving needs and system demands. The FlexiShield FLS trip units empower users with the freedom to customize their ACB's capabilities for optimal performance and advanced protection.



Trip Units

Key Features



FLS 1.0

- Overload, Short-circuit & Instantaneous protection with adjustable current & time-delay settings
- Inbuilt Earth-Fault & neutral protection in FLS 1G/1Gi & FLS 1.5G/1.5Gi
- Switchable thermal memory for cable protection on repetitive overloads

FLS 1G/1Gi

- I^2t ON curve for Short-circuit & Earth-fault protection
- Current Metering in FLS 1.5G/1.5Gi through 3-line O-LED display
- Local fault annunciation through LED indication & pre-trip alarm
- Front accessible test port
- Query button for last trip record

FLS 1.5G/1.5Gi

- Inbuilt rating-plu through DIP switches
- Test button to check the health of protection release
- Self-powered protection
- Inbuilt Zone Selective Interlocking (ZSI) in FLS 1Gi & FLS 1.5Gi

| Parameters | | FLS 1.0 | FLS 1G | FLS 1Gi | FLS 1.5G | FLS 1.5Gi |
|--------------------|-------------------------------|---|-------------------------|---------|----------|-----------|
| Overload (Phase) | Protection: Enable/Disable | ✓ | ✓ | ✓ | ✓ | ✓ |
| | Pick-up (I_r)= I_n x... | OFF-0.4-0.5-0.6-0.7-0.8-0.85-0.9-0.95-1 | | | | |
| | Delay (tr) in sec | 10 | 0.5-1-2-4-6-12-18-24-30 | | | |
| | Pre-alarm | 0.9 x I_r (fixed) | | | | |
| | Thermal Memory ON/OFF | ✓ | ✓ | ✓ | ✓ | ✓ |
| Overload (Neutral) | Protection: Enable/Disable | - | ✓ | ✓ | ✓ | ✓ |
| | Pick-up (I_n)= I_r x... | - | 50%-100%-150%-200% | | | |
| | Pre-alarm | - | 0.8 x I_n (fixed) | | | |
| | Delay (tr) in s | - | Same as Overload Phase | | | |
| Short-Circuit | Protection: Enable/Disable | - | - | - | - | - |
| | I^2t ON/OFF | ✓ | ✓ | ✓ | ✓ | ✓ |
| | Pick-up (I_s)= I_n x... | 0.6-1-1.5-2-3-4-6-8-10-12 | | | | |
| | Delay (ts) | 20-100-200-300-400 ms | | | | |
| Instantaneous | Pre-alarm | 0.5 x I_s (fixed) | | | | |
| | Protection: Enable/Disable | ✓ | ✓ | ✓ | ✓ | ✓ |
| | Pick-up (I_p)= I_n x... | OFF-1.5-2-3-4-6-8-10-12-15 | | | | |
| Earth-Fault | Protection: Enable/Disable | - | ✓ | ✓ | ✓ | ✓ |
| | I^2t : ON/OFF | - | ✓ | ✓ | ✓ | ✓ |
| | Pick-up (I_g)= I_n x... | - | OFF-0.2-0.3-0.4-0.5-0.6 | | | |
| | I^2t OFF (tg) | - | 0.1-0.2-0.3-0.4-1 | | | |
| | I^2t ON (tg) | - | 0.1-0.2-0.3-0.4 | | | |
| Inbuilt-ZSI | Pre-alarm | 0.8 x I_g (fixed) | | | | |
| | Short Circuit Enable/Disable | - | - | ✓ | - | ✓ |
| Metering | Earth Fault Enable/Disable | - | - | ✓ | - | ✓ |
| | Current | - | - | - | ✓ | ✓ |
| | % Loading | - | - | - | ✓ | ✓ |
| | Max. & Min. Current | - | - | - | ✓ | ✓ |
| Trip Records | Current Bar-graph | - | - | - | ✓ | ✓ |
| | Last 20 trip data | - | - | - | ✓ | ✓ |



FLS 3.5/3.5EC/3.5H



FLS 3.5H



FLS 4.5G

| Features | Parameter | FLS 3.5 | FLS 3.5EC | FLS 3.5H | FLS 4.5 |
|----------------------------|-----------------------------------|---------|-----------|----------|---------|
| Basic Protection | Overload - Phase | ✓ | ✓ | ✓ | ✓ |
| | Overload - Neutral | ✓ | ✓ | ✓ | ✓ |
| | Short-Circuit | ✓ | ✓ | ✓ | ✓ |
| | Directional Short-Circuit | ✓ | ✓ | ✓ | ✓ |
| | Instantaneous | ✓ | ✓ | ✓ | ✓ |
| | Earth-Fault | ✓ | ✓ | ✓ | ✓ |
| Additional Protection | Current | ✓ | ✓ | ✓ | ✓ |
| | Voltage | * | ✓ | ✓ | ✓ |
| | Frequency | * | ✓ | ✓ | ✓ |
| | Reverse Power | * | ✓ | ✓ | ✓ |
| | Maximum Demand | * | ✓ | ✓ | ✓ |
| Trip Records | Last 20 trip data | ✓ | ✓ | ✓ | ✓ |
| Event Records | Last 10 Event Data | ✓ | ✓ | ✓ | ✓ |
| Smart Card | | * | * | * | * |
| Communication | Modbus | * | ✓ | * | ✓ |
| | Profibus | * | * | * | * |
| | Zigbee (wireless) | * | * | * | * |
| Advanced Protection | Trip Circuit Supervision (TCS) | * | * | * | * |
| | Zone Selective Interlocking (ZSI) | * | * | * | * |
| | Temperature Rise (TM) | * | * | * | * |
| | Earth Leakage (EL) | * | * | * | * |
| | Restricted Earth-Fault (REF) | * | * | * | * |
| Additional Features | Relay Output | * | * | * | * |
| | Load Management (Pre Trip Alarm) | ✓ | ✓ | ✓ | ✓ |
| | Digital Input & Output | * | * | * | * |
| | Analog Output | * | * | * | * |
| Metering | Current | ✓ | ✓ | ✓ | ✓ |
| | % Loading | ✓ | ✓ | ✓ | ✓ |
| | Voltage | * | ✓ | ✓ | ✓ |
| | Power & Energy | * | ✓ | ✓ | ✓ |
| | Harmonics | - | - | ✓ | ✓ |
| Storable Settings (2 sets) | | ✓ | ✓ | ✓ | ✓ |
| Auxiliary Supply (24V DC) | | * | * | * | ✓ |

* - Optional feature

✓ - Standard



FlexiShield FLS 3.5/3.5EC

- Overload, Short-circuit and Earth-fault protection with variable current & time delay setting
- Instantaneous protection I, I²t, SI, LI/VI protection curves
- Directional & Double Short circuit protections
- Reverse power and phase sequence protection
- Selectable It based curves for short-circuit and earth-fault protection
- Switchable neutral overload protection (50%-200%) in step of 5%
- Additional current & voltage based protections
- Protection against temperature rise
- Advance protection - ZSI, TCS, REF & EL
- Communication through Modbus, Profibus & wireless Zigbee
- Smart Configurator module for easy parameterisation of the release
- Local & remote fault annunciation & pre-trip alarm
- Current, Voltage, Power, Energy & THD metering & % loading
- Earth Fault Protection from 10%In
- Dual time-based protection set groups
- Thermal reflectivity & soft rating-plug
- Self-powered protection Trip & Event recording



FlexiShield FLS 3.5H

- Overload, Short-circuit and Earth-fault protection with variable current & time delay setting
- Instantaneous protection I, I²t, SI, LVI protection curves
- Current & Voltage harmonics metering
- Directional & Double Short circuit protections
- Reverse power and phase sequence protection
- Selectable It based curves for short-circuit and earth-fault protection
- Switchable neutral overload protection (50%-200%) in step of 5%
- Additional current & voltage based protections
- Protection against temperature rise
- Advance protection - ZSI, TCS, REF & EL
- Optional communication through Modbus, Profibus & wireless Zigbee
- Smart Configurator module for easy parameterisation of the release
- Local & remote fault annunciation & pre-trip alarm
- Current, Voltage, Power, Energy & THD metering & % loading
- Dual time-based protection set groups
- Thermal reflectivity & soft rating-plug
- Self-powered protection Trip & Event recording



FlexiShield FLS 4.5

- Overload, Short-circuit and Earth-fault protection with variable current & time delay setting
- I^2t , I^4t , SI, LIVI protection curves
- Navigation through Touch-Screen
- Bar-graph representation of current, voltage & power parameters
- Directional & Double Short-circuit protection
- Instantaneous protection
- Selectable I^2t based curves for Short-circuit and Earth-fault protection
- Switchable neutral overload protection (50%-200%) in step of 5%
- Harmonics metering up to 27th order of fundamental frequency along with display of THD percentage
- Oscillograph of fault current waveforms (10 cycles before pick-up/Trip & 5 cycles after pick-up/Trip)
- Metering of sequence components of current waveform, form factor, peak factor
- Additional current & voltage based protections
- Protection against temperature rise
- Advance protection - ZSI, TCS, REF & EL
- Communication through Modbus, Profibus & wireless Zigbee
- Local & remote fault annunciation & pre-trip alarm
- Dual time-based protection set groups Thermal reflectivity & soft rating-plug Self-powered protection
- Trip & Event recording

Simulation kit for FlexiShield FLS releases

- Universal test kit for all versions of FlexiShield releases
- Generates 3 phase current and voltage with adjustable phase angles
- Graphical display & smart GUI with multi-functional key operation
- Portable & hand-held device to simulate faults
- Dual Power ON-battery & external supply
- Auto-sensing of release connectivity
- Stores up to 10 test records



Basic Protection in FLS 3.5/3.5EC/3.5H/4.5 Series

| | Parameter | FLS 3.5 | FLS 3.5EC | FLS 3.5H | FLS 3.5H/4.5 |
|---------------------------|--|---|-----------|----------|--------------|
| Overload (Phase) | Protection : Enable/Disable | ✓ | ✓ | ✓ | ✓ |
| | Pick-Up (I_r)= I_n x ...for I^2t , I^1t , SI, LIWI | 0.4 to 1 In in step of 0.05 | | | |
| | Delay(t_r) in s | 0.5-1-2-4-6-12-18-24-30 | | | |
| | Pre-alarm | 0.5 to 0.95 in step of 0.05 x I_r | | | |
| | Thermal Memory ON/OFF | ✓ | ✓ | ✓ | ✓ |
| Overload (Neutral) | Protection: Enable/Disable | ✓ | ✓ | ✓ | ✓ |
| | Pick-Up $I_n=I_r$ x ... | 0.5 to 2 in step of 0.05 | | | |
| | Pre-alarm | 0.5 to 0.95 in step of 0.05 x I_n | | | |
| | Delay(t_r) in s | same as Overload Phase | | | |
| Short-Circuit | Protection: Enable/Disable | ✓ | ✓ | ✓ | ✓ |
| | Double S/C ON/OFF | ✓ | ✓ | ✓ | ✓ |
| | I^2t ON/OFF | ✓ | ✓ | ✓ | ✓ |
| | Pick-Up I_o , $I_s=I_n$ x ... | 0.6 to 12 In in step of 0.05 | | | |
| | Pick-Up I_{hi} , $I_s=I_n$ x ... | 0.6 to 12 In in step of 0.05 | | | |
| | Delay I_{hi} (ts) | 20-100-200-300-400 ms | | | |
| | Delay I_o (ts) | 20-100-200-300-400 ms | | | |
| | Pre-alarm | 0.5 to 0.95 in step of 0.05 x I_s | | | |
| | Cold Pick-Up ON/OFF | ✓ | ✓ | ✓ | ✓ |
| | Cold Delay | 100 ms to 10s in step of 100ms | | | |
| Directional Short-Circuit | Protection: Enable/Disable | ✓ | ✓ | ✓ | ✓ |
| | Direction: Top/Bottom | ✓ | ✓ | ✓ | ✓ |
| | I^1t : ON/OFF | ✓ | ✓ | ✓ | ✓ |
| | Pick-up(I_s): I_n x ... | 0.6 to 12 In in step of 0.05 | | | |
| | Delay(ts) | 20-100-200-300-400 ms | | | |
| | Pre-alarm | 0.5 to 0.95 in step of 0.05 x I_s | | | |
| | Cold Pick-Up ON/OFF | ✓ | ✓ | ✓ | ✓ |
| | Cold Delay | 100 ms 10s in step of 0.05 x I_s | | | |
| Instantaneous | Protection: Enable/Disable | ✓ | ✓ | ✓ | ✓ |
| | Pick-up(I_p)= I_n x ... | 1.5 to 10 in step of 0.1; 10 to 15 in step of 1 | | | |
| Earth-Fault | Protection: Enable/Disable | ✓ | ✓ | ✓ | ✓ |
| | I^2t : ON/OFF | ✓ | ✓ | ✓ | ✓ |
| | Pick-Up(I_g)= I_n x ... | 0.1-0.2-0.3-0.4-0.5-0.6 | | | |
| | I^1t OFF(tg) | 100 ms to 1s in step of 100 ms | | | |
| | I^1t ON(tg) | 100-200-300-400 ms | | | |
| | Pre-alarm | 0.5 to 0.95 in step of 0.05 x I_g | | | |
| | Cold Pick-Up: ON/OFF | ✓ | ✓ | ✓ | ✓ |
| | Cold Delay | 100ms to 5sec in step of 100 ms | | | |



Ordering Information

Manually Drawn Out /
Electrically Drawn Out versions

MDO Models

| Frame | Model | CAT Code | Rating | Remark |
|-------------|-------------|------------|--------|--|
| 3 Pole | E3DLMD 800 | E3DLMD0800 | 800A | Breaking Capacity: 50/65/80/100 kA |
| | E3DLMD 1000 | E3DLMD1000 | 1000A | |
| | E3DLMD 1250 | E3DLMD1250 | 1250A | |
| | E3DLMD 1600 | E3DLMD1600 | 1600A | |
| | E3DLMD 2000 | E3DLMD2000 | 2000A | |
| | E3DLMD 2500 | E3DLMD2500 | 2500A | |
| | E3DLMD 3200 | E3DLMD3200 | 3200A | |
| | E3DLMD 4000 | E3DLMD4000 | 4000A | |
| E3DLMD 6300 | E3DLMD6300 | 6300A | | |
| 4 Pole | E4DLMD 800 | E4DLMD0800 | 800A | |
| | E4DLMD 1000 | E4DLMD1000 | 1000A | |
| | E4DLMD 1250 | E4DLMD1250 | 1250A | |
| | E4DLMD 1600 | E4DLMD1600 | 1600A | |
| | E4DLMD 2000 | E4DLMD2000 | 2000A | |
| | E4DLMD 2500 | E4DLMD2500 | 2500A | |
| | E4DLMD 3200 | E4DLMD3200 | 3200A | |
| | E4DLMD 4000 | E4DLMD4000 | 4000A | |
| E4DLMD 6300 | E4DLMD6300 | 6300A | | |

EDO Models

| Frame | Model | CAT Code | Rating | Remark |
|-------------|-------------|------------|--------|--|
| 3 Pole | E3DLED 800 | E3DLED0800 | 800A | Breaking Capacity: 50/65/80/100 kA |
| | E3DLED 1000 | E3DLED1000 | 1000A | |
| | E3DLED 1250 | E3DLED1250 | 1250A | |
| | E3DLED 1600 | E3DLED1600 | 1600A | |
| | E3DLED 2000 | E3DLED2000 | 2000A | |
| | E3DLED 2500 | E3DLED2500 | 2500A | |
| | E3DLED 3200 | E3DLED3200 | 3200A | |
| | E3DLED 4000 | E3DLED4000 | 4000A | |
| E3DLED 6300 | E3DLED6300 | 6300A | | |
| 4 Pole | E4DLED 800 | E4DLED0800 | 800A | |
| | E4DLED 1000 | E4DLED1000 | 1000A | |
| | E4DLED 1250 | E4DLED1250 | 1250A | |
| | E4DLED 1600 | E4DLED1600 | 1600A | |
| | E4DLED 2000 | E4DLED2000 | 2000A | |
| | E4DLED 2500 | E4DLED2500 | 2500A | |
| | E4DLED 3200 | E4DLED3200 | 3200A | |
| | E4DLED 4000 | E4DLED4000 | 4000A | |
| E4DLED 6300 | E4DLED6300 | 6300A | | |

Overload - I^2t

(FLS 1.0/1G/1Gi/1.5G/1.5Gi/3.5/3.5EC/3.5H/4.5)

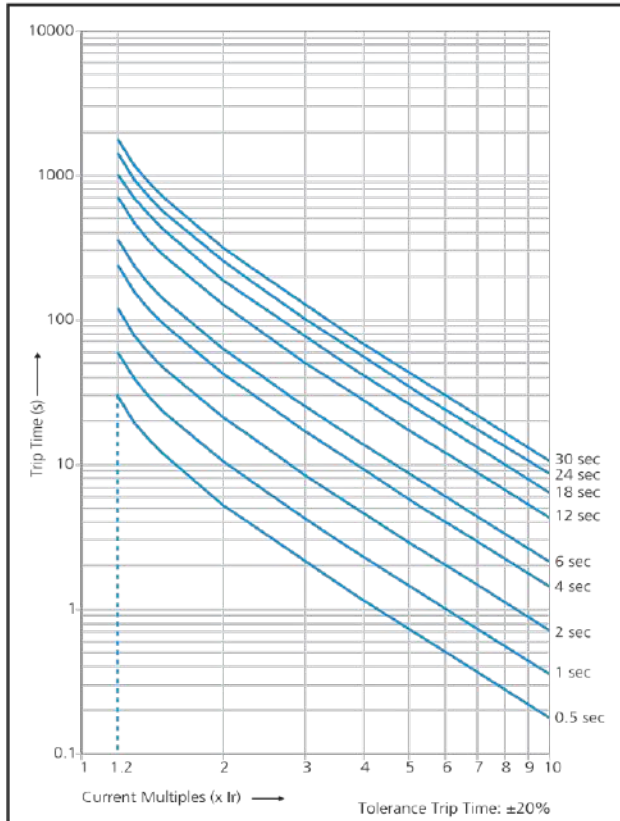

Instantaneous - I^2t

(FLS 1.0/1G/1Gi/1.5G/1.5Gi/3.5/3.5EC/3.5H/4.5)

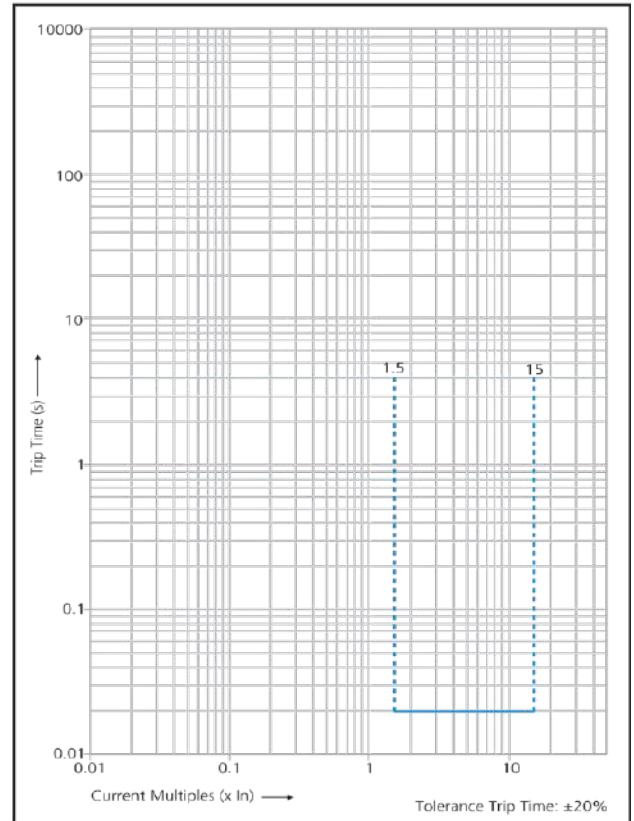

Short-Circuit - I^2t ON

(FLS 1.0/1G/1Gi/1.5G/1.5Gi/3.5/3.5EC/3.5H/4.5)

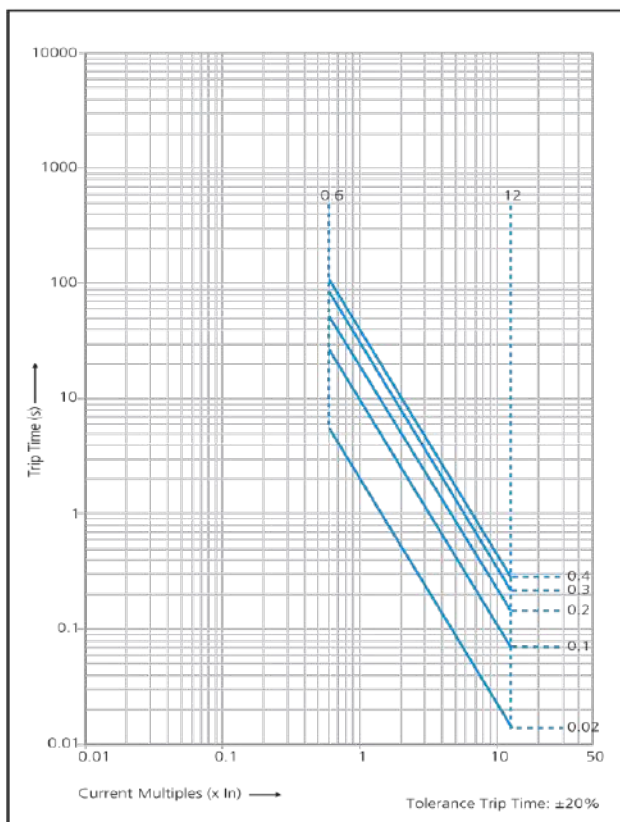

Short-circuit - I^2t OFF

(FLS 1.0/1G/1Gi/1.5G/1.5Gi/3.5/3.5EC/3.5H/4.5)

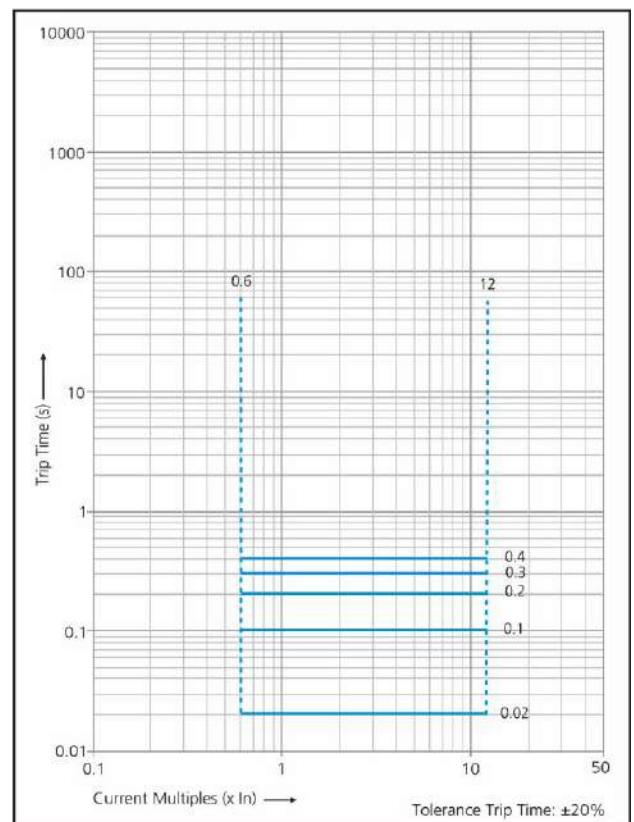

Ground Fault - I²t ON

(FLS 1.0/1G/1Gi/1.5G/1.5Gi/3.5/3.5EC/3.5H/4.5)

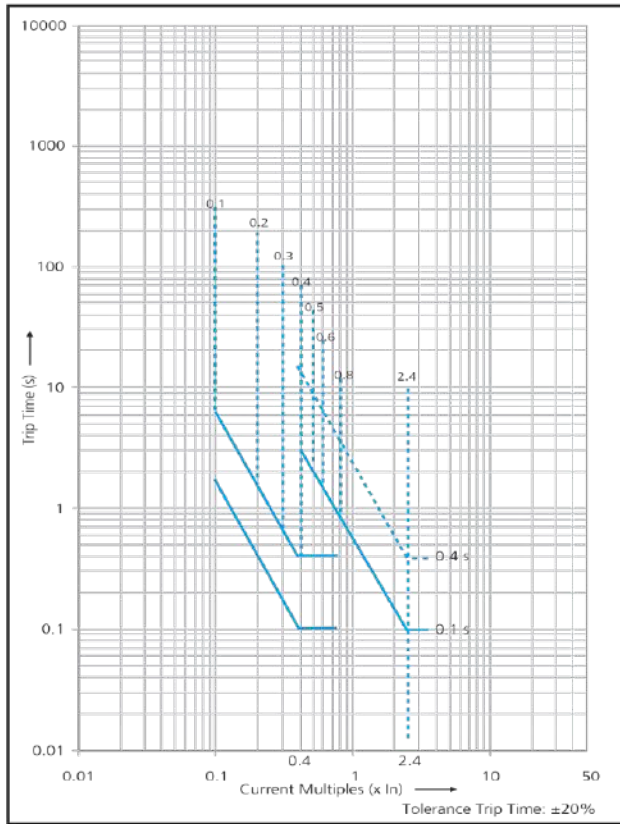

Ground Fault - I²t OFF

(FLS 1.0/1G/1Gi/1.5G/1.5Gi/3.5/3.5EC/3.5H/4.5)

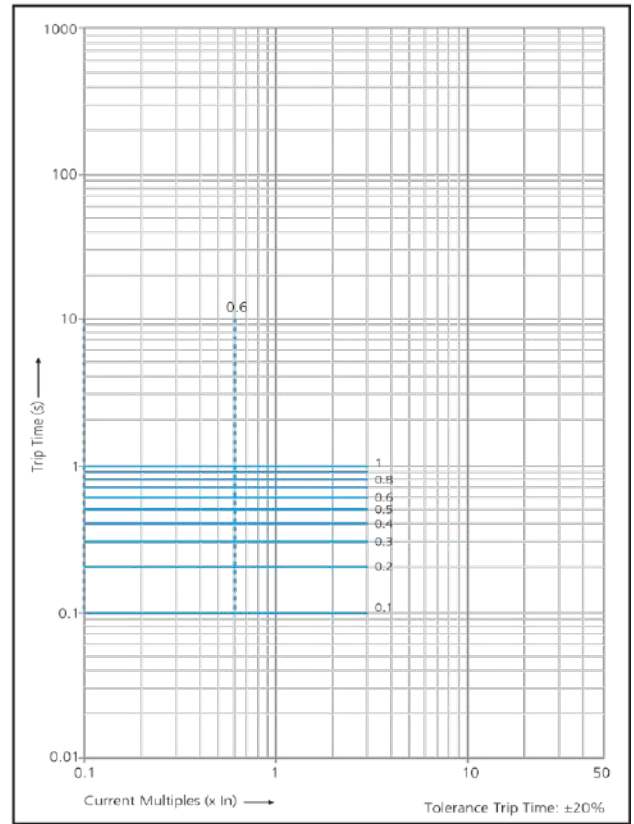

Overload - I²t

(FLS 1.0)

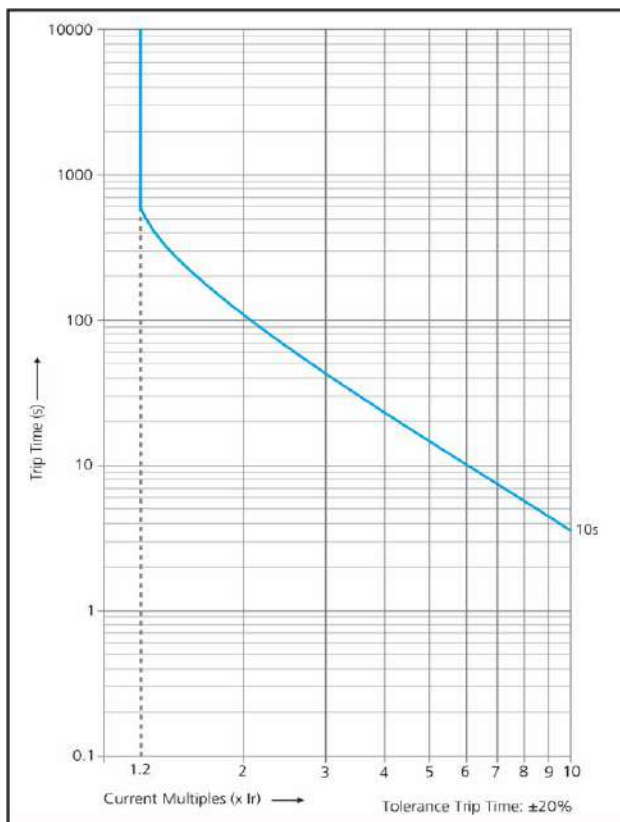

Overload - I⁴t

(FLS 3.5/3.5EC/3.5H/4.5)

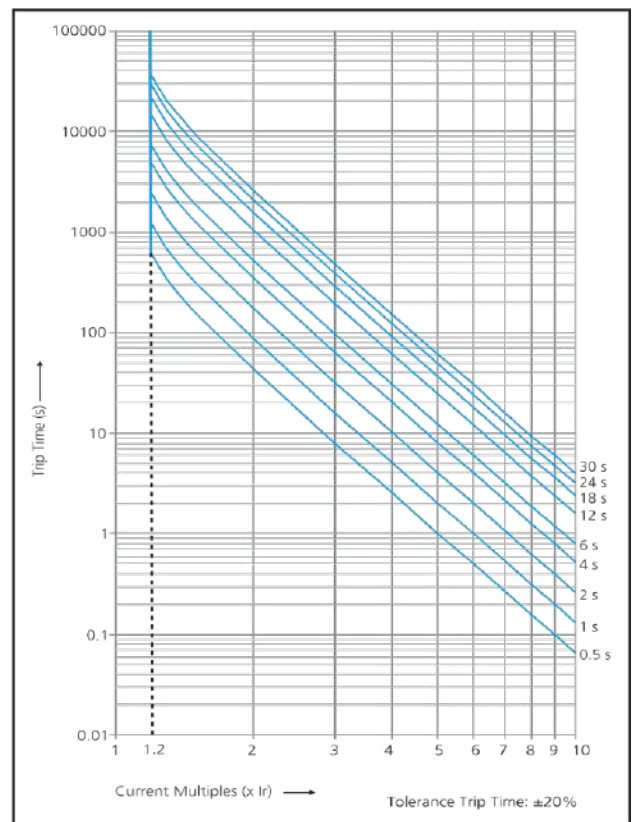

Overload - SI

(FLS 3.5/3.5EC/3.5H/4.5)

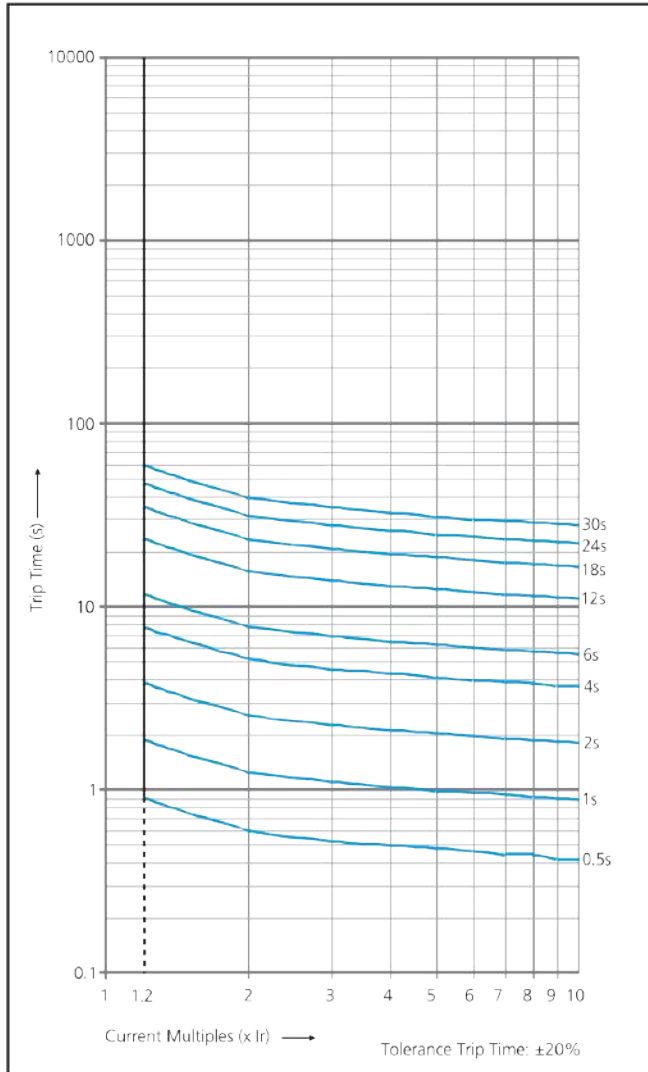

Overload - LI/VI

(FLS 3.5/3.5EC/3.5H/4.5)

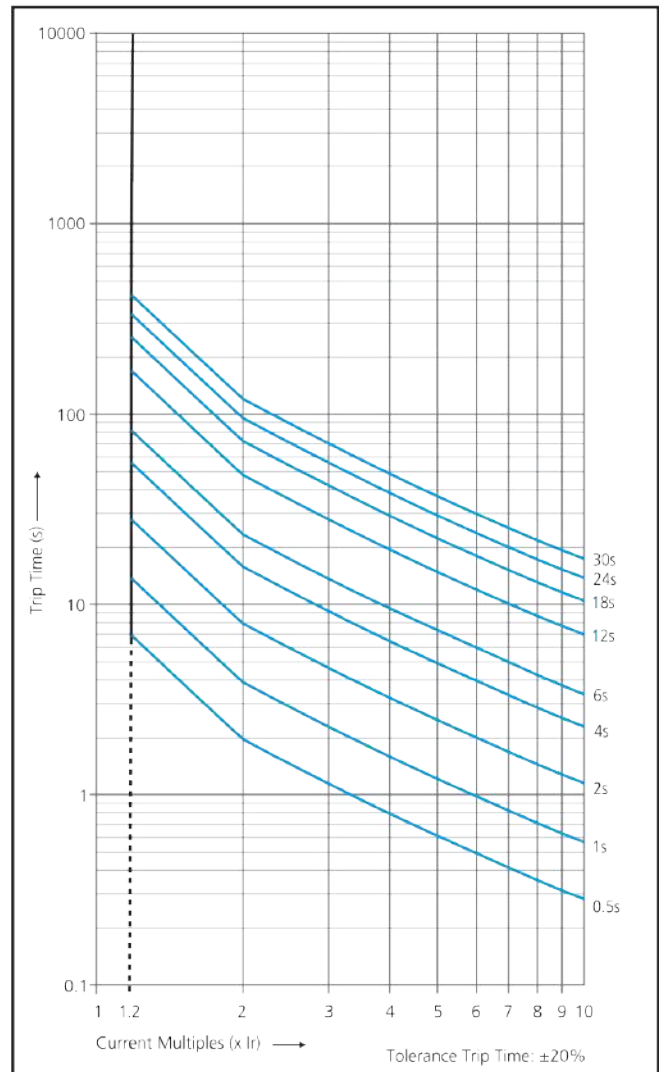

Delta ACB upto 690V AC

Technical Specification

| Technical Parameters | | | Specifications | | | | | | | | | | | |
|--|----------------------------|--------------|--|--------|------|-------|------|----------|-------|-----|----------|-----|------|-----|
| Rated uninterrupted current (In) (A) at 50°C | | | 400-2000 | | | 2500 | | 400-4000 | | | 400-5000 | | 6300 | |
| Version | | | N | S | H | S | H | N | S | H | H | V | H | V |
| Rated operational voltage at 50/60Hz | <i>U_e</i> | | Upto 690V AC | | | | | | | | | | | |
| Rated insulation voltage at 50/60Hz | <i>U_i</i> | | 1000V AC | | | | | | | | | | | |
| Rated impulse withstand voltage | <i>U_{imp}</i> | | 12kV (main circuit) & 4kV (Auxiliary circuit) | | | | | | | | | | | |
| Suitability for isolation | | | Yes | | | | | | | | | | | |
| Degree of protection on breaker front | | | IP53 standard, IP54 optional | | | | | | | | | | | |
| Degree of impact protection on breaker front | | | IK08 standard, IK10 optional | | | | | | | | | | | |
| Pollution degree suitability | | | 4 | | | | | | | | | | | |
| Utilization category | | | B | | | | | | | | | | | |
| Compliance | | | IS / IEC 60947 (Part-2), EN 60947-2, IEC 60947-2 | | | | | | | | | | | |
| Operational temperature range (As per IEC 60068-1 / IEC 60947-1Q) | | | -25°C to 70°C | | | | | | | | | | | |
| Storage temperature range (As per IEC 60068-2-1/2) | | | -40°C to 85°C | | | | | | | | | | | |
| Rated ultimate S.C. breaking capacity | <i>I_{cu}</i> (kA) | 415 /440V AC | 50 | 65 | 80 | 65 | 80 | 50 | 65 | 80 | 80 | 100 | 80 | 100 |
| | | 500/550V AC | 42 | 55 | 65 | 55 | 65 | 42 | 55 | 70 | 70 | 85 | 70 | 85 |
| | | 660/690V AC | 36 | 50 | 55 | 50 | 55 | 36 | 50 | 65 | 65 | 75 | 65 | 75 |
| Rated service S.C. breaking capacity | <i>I_{cs}</i> (kA) | 415 /440V AC | 100% <i>I_{cu}</i> | | | | | | | | | | | |
| | | 500/550V AC | | | | | | | | | | | | |
| | | 660/690V AC | | | | | | | | | | | | |
| Rated short-time withstand capacity | <i>I_{cw}</i> (kA) | 0.5 sec. | 50 | 65 | 80 | 65 | 80 | 50 | 65 | 80 | 80 | 100 | 80 | 100 |
| | | 1.0 sec. | 50 | 65 | 80 | 65 | 80 | 50 | 65 | 80 | 80 | 100 | 80 | 100 |
| | | 3.0 sec. | 26 | 36 | 44 | 36 | 44 | 26 | 44 | 50 | 65 | 75 | 65 | 75 |
| Rated S.C. making capacity | <i>I_{cm}</i> (kA) | 415 /440V AC | 105 | 143 | 176 | 143 | 176 | 105 | 143 | 176 | 176 | 220 | 176 | 220 |
| | | 500/550V AC | 88 | 121 | 143 | 121 | 143 | 88 | 121 | 154 | 154 | 187 | 154 | 187 |
| | | 660/690V AC | 76 | 105 | 121 | 105 | 121 | 76 | 105 | 143 | 143 | 165 | 143 | 165 |
| Break time (ms) | | | 25 | | | | | | | | | | | |
| Closing time (ms) | | | 60 | | | | | | | | | | | |
| Mechanical life | With routine maintenance | | 20000 | | | 15000 | | | 10000 | | | | | |
| Electrical Life | With specific maintenance | | 20000 | | | 15000 | | | 10000 | | | | | |
| | With specific maintenance | | 10000 | | 5000 | | 5000 | | 5000 | | 2000 | | | |
| Dimensions | Fixed ACB | W (mm) | Width 3P | 347 | | | 447 | | | 647 | | | | |
| | | | Width 4P | 447 | | | 581 | | | 847 | | | | |
| | | D (mm) | Depth | 324 | | | | | | 334 | | | | |
| | | | H (mm) | Height | 430 | | | | | | | | | |
| Dimensions | Draw-out ACB | W (mm) | Width 3P | 347 | | | 447 | | | 647 | | | | |
| | | | Width 4P | 447 | | | 581 | | | 847 | | | | |
| | | D (mm) | Depth | 421 | | | | | | 431 | | | | |
| | | | H (mm) | Height | 433 | | | | | | | | | |

Delta ACB 800V AC

Technical Specification

| Technical Parameters | | | Specifications | | | | |
|--|---------------------------|----------|--|-----------------|-----------------|-----------------|-----|
| Rated uninterrupted current (In) (A) at 50°C | | | 400-2000 | 400-4000 | 400-5000 | 400-5000 | |
| Version | | | N08 | | | S08 | |
| Rated operational voltage at 50/60Hz | <i>Ue</i> | | 800V AC | | | | |
| Rated insulation voltage at 50/60Hz | <i>Ui</i> | | 1250V AC | | | | |
| Rated impulse withstand voltage | <i>Uimp</i> | | 12kV (main circuit) & 4kV (Auxiliary circuit) | | | | |
| Suitability for isolation | | | Yes | | | | |
| Degree of protection on breaker front | | | IP53 standard, IP54 optional | | | | |
| Degree of impact protection on breaker front | | | IK08 standard, IK10 optional | | | | |
| Pollution degree suitability | | | 4 | | | | |
| Utilization category | | | B | | | | |
| Compliance | | | IS / IEC 60947 (Part-2), EN 60947-2, IEC 60947-2 | | | | |
| Operational temperature range (As per IEC 60068-1 / IEC 60947-1Q) | | | -25°C to 70°C | | | | |
| Storage temperature range (As per IEC 60068-2-1½) | | | -40°C to 85°C | | | | |
| Rated ultimate S.C. breaking capacity | <i>Icu</i> (kA) | 800V AC | 50 | | | 65 | |
| Rated service S.C. breaking capacity | <i>Ics</i> (kA) | 800V AC | 100% <i>Icu</i> | | | | |
| Rated short-time withstand capacity | <i>Icw</i> (kA) | 1.0 sec. | 50 | | | 65 | |
| | | 3.0 sec. | 36 | 50 | | 65 | |
| Rated S.C. making capacity | <i>Icm</i> (kA) | 800V AC | 105 | | | 143 | |
| Break time (ms) | | | 25 | | | | |
| Closing time (ms) | | | 60 | | | | |
| Mechanical life | With routine maintenance | | 20000 | 15000 | 10000 | | |
| Electrical Life | With specific maintenance | | 20000 | 15000 | 10000 | | |
| | With routine maintenance | | 1000 | | | | |
| Dimensions | Fixed ACB | W (mm) | Width 3P | 347 | 447 | 647 | |
| | | | Width 4P | 447 | 581 | 847 | |
| | | D (mm) | Depth | 324 | | | 334 |
| | | H (mm) | Height | 430 | | | |
| | Draw-out ACB | W (mm) | Width 3P | 347 | 447 | 647 | |
| | | | Width 4P | 447 | 581 | 847 | |
| | | D (mm) | Depth | 421 | | | 431 |
| | | H (mm) | Height | 433 | | | |

Delta ACB - Termination

Draw out Breakers

400A-1600A N/S/H, Fr.1 3P

Flat Terminals

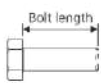
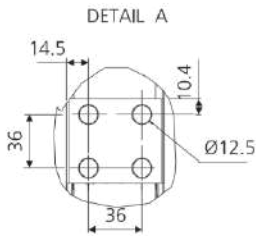

Bolt length for mounting link(s) on Flat Terminals to be cumulative link(s) Thickness + 20 min to 25 max

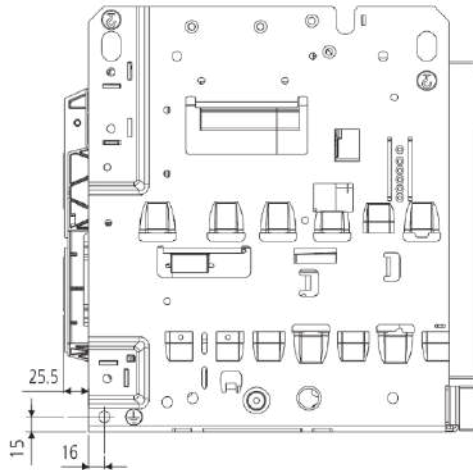

M12/ Equivalent BS bolts to be used for links termination. Tightening torque: 3.2 kgfm

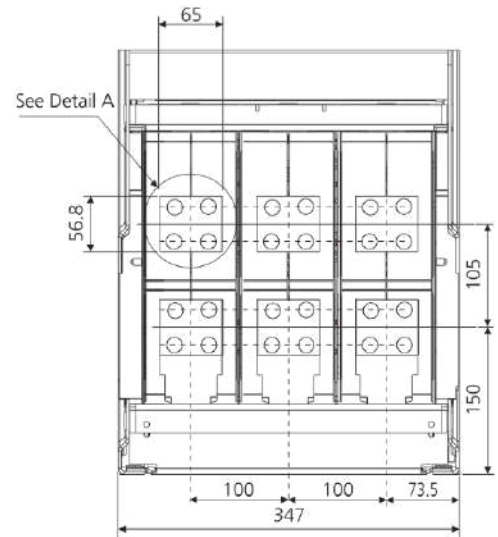

Horizontal Terminals

400A-2000A N/S/H

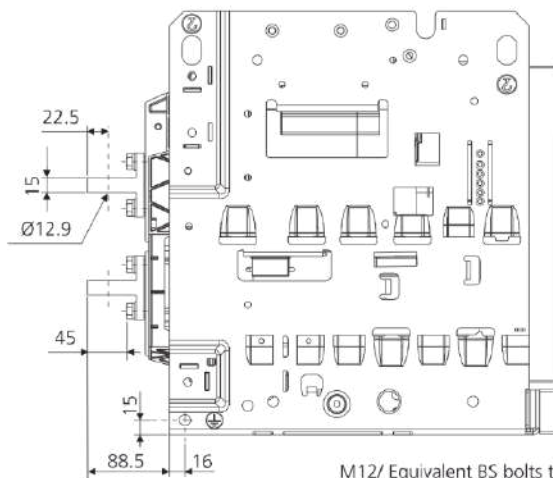

M12/ Equivalent BS bolts to be used for links termination. Tightening torque: 3.2 kgfm

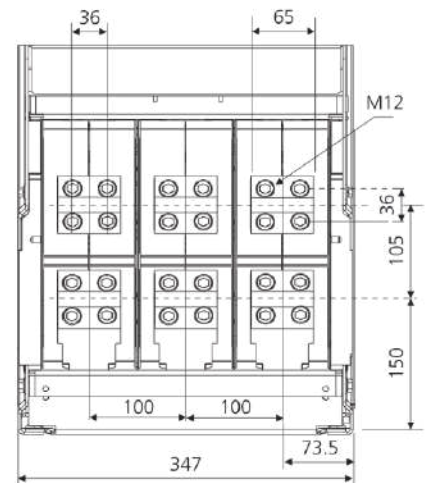

Vertical Terminals

400A-2000A N/S/H

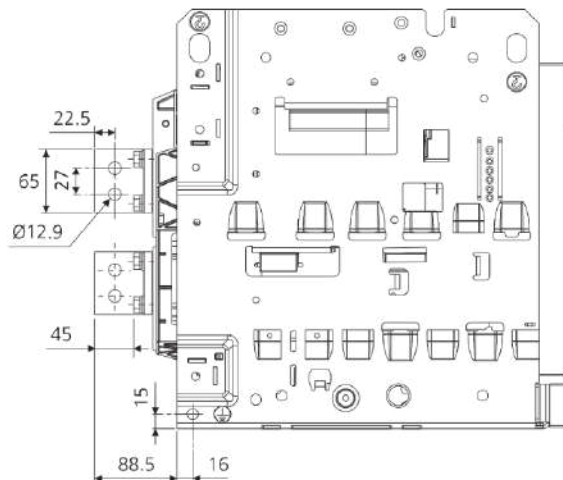

M12 / Equivalent BS bolts to be used for links termination Tightening torque: 3.2 kgfm

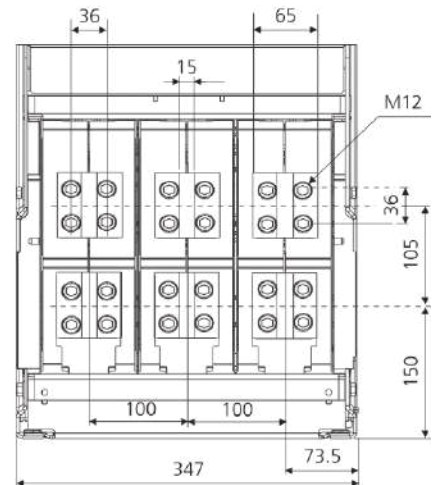

All Dimensions in mm

Delta ACB - Termination

Draw out Breakers

2500A S & 400-2500A H Fr.1-3P Vertical Terminals

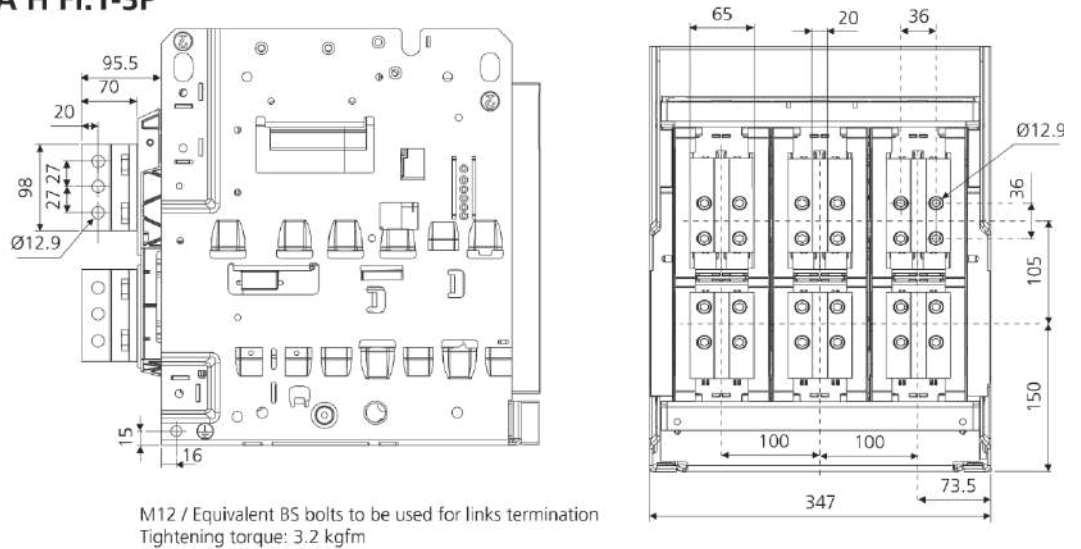

400A-2000A, N/S/H Fr.1-4P (100%N) Flat Terminals 400A- 1600A, N/S/H

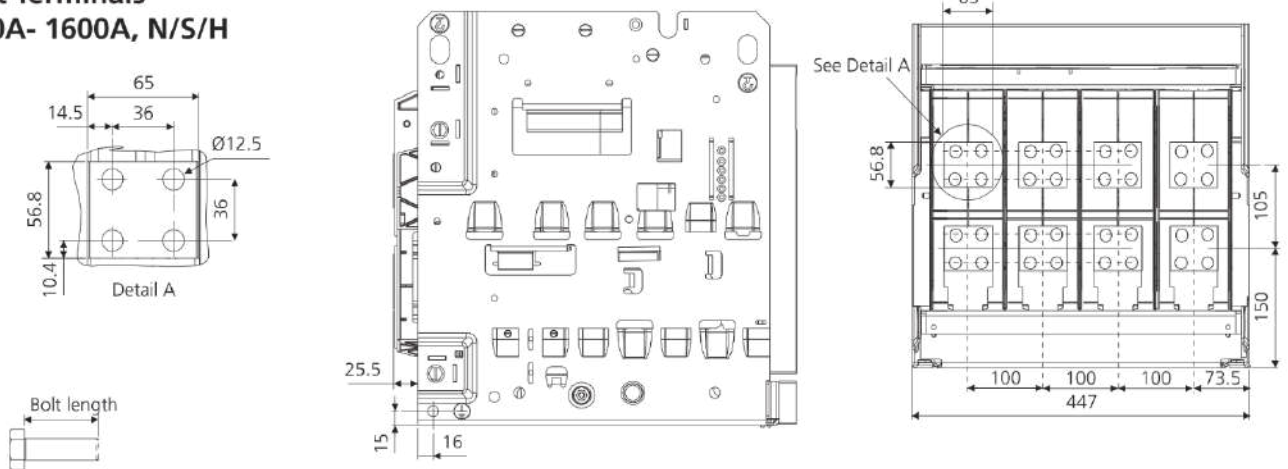

Bolt length for mounting link(s) on Flat Terminals to be cumulative link(s) thickness +20 min to 25 max.

M12/ Equivalent BS bolts to be used for links termination. Tightening torque: 3.2 kgfm

Horizontal Terminals 400A - 2000A N/S/H

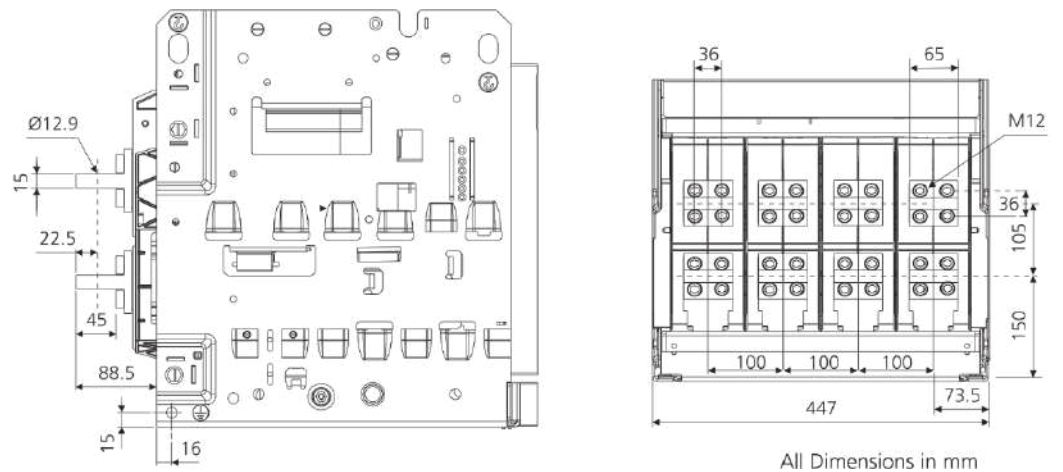

All Dimensions in mm

Delta ACB - Termination

Draw out Breakers

Vertical Terminals

400A - 2000A N/S/H

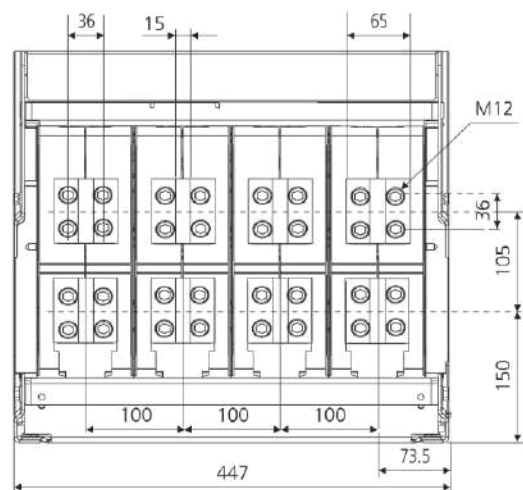
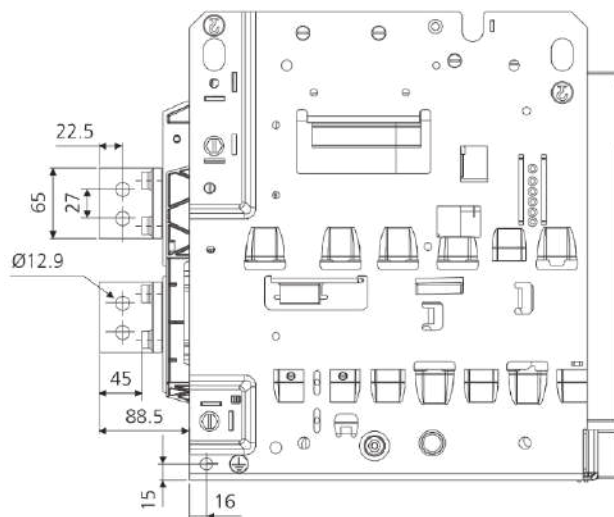

M12 / Equivalent B5 bolts to be used for links termination
Tightening torque: 3.2 kgfm

Vertical Terminals

2500A S & 400-2500A H, Fr.1-4P (100%N)

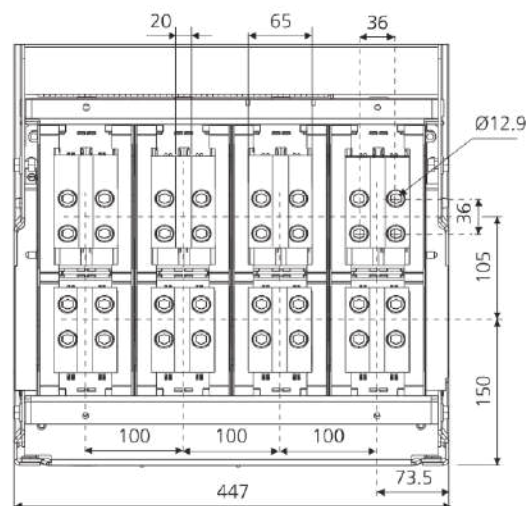
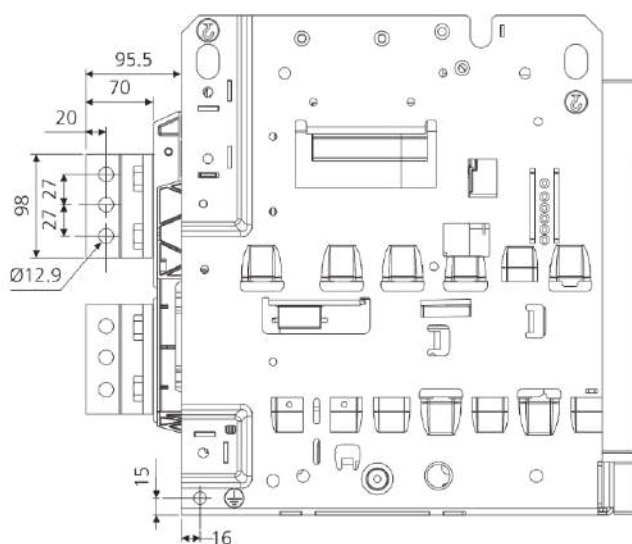

M12/ Equivalent B5 bolts to be used for links termination.
Tightening torque: 3.2 kgfm

All Dimensions in mm

Delta ACB - Termination

Draw out Breakers

400A-3200A, N/S/H Fr.2-3P

Flat Terminals

400A-1600A, N/S/H

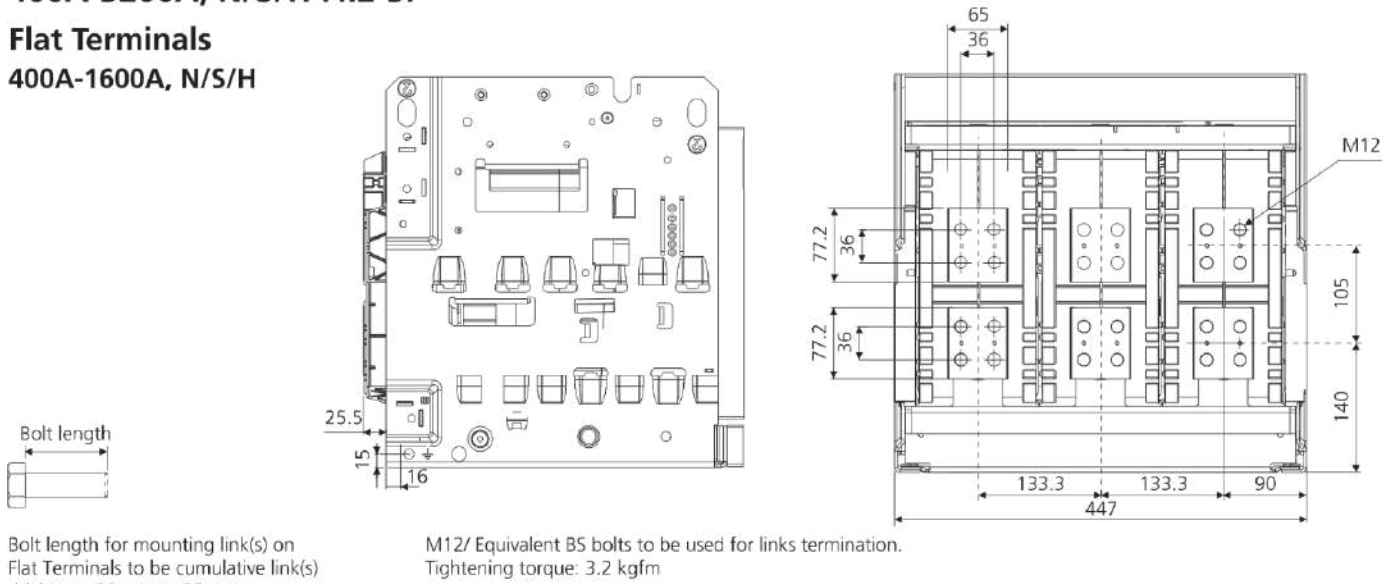

Horizontal Terminals

400A-3200A, N/S/H

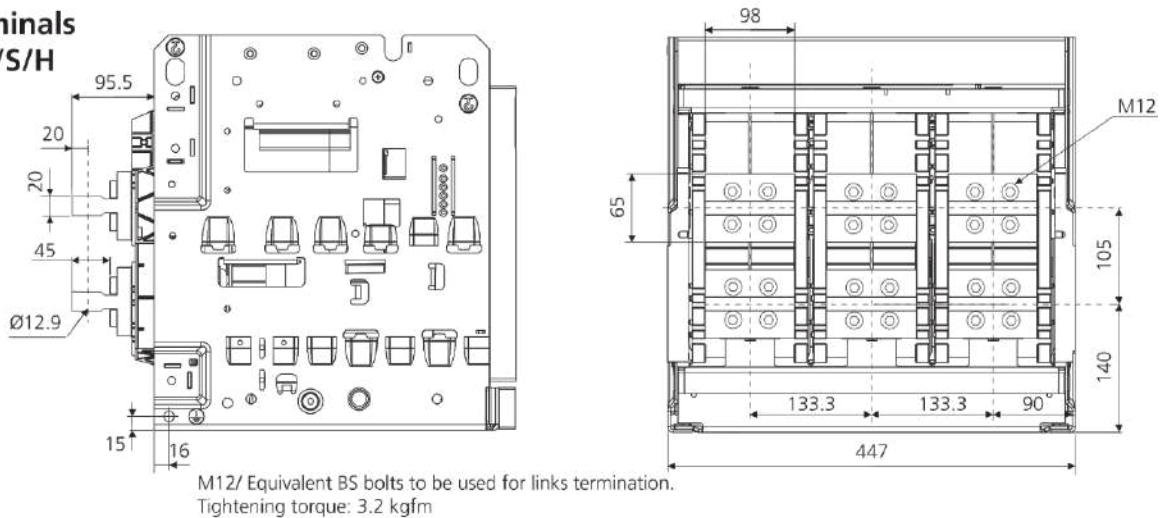

Vertical Terminals

400A-3200A, N/S/H

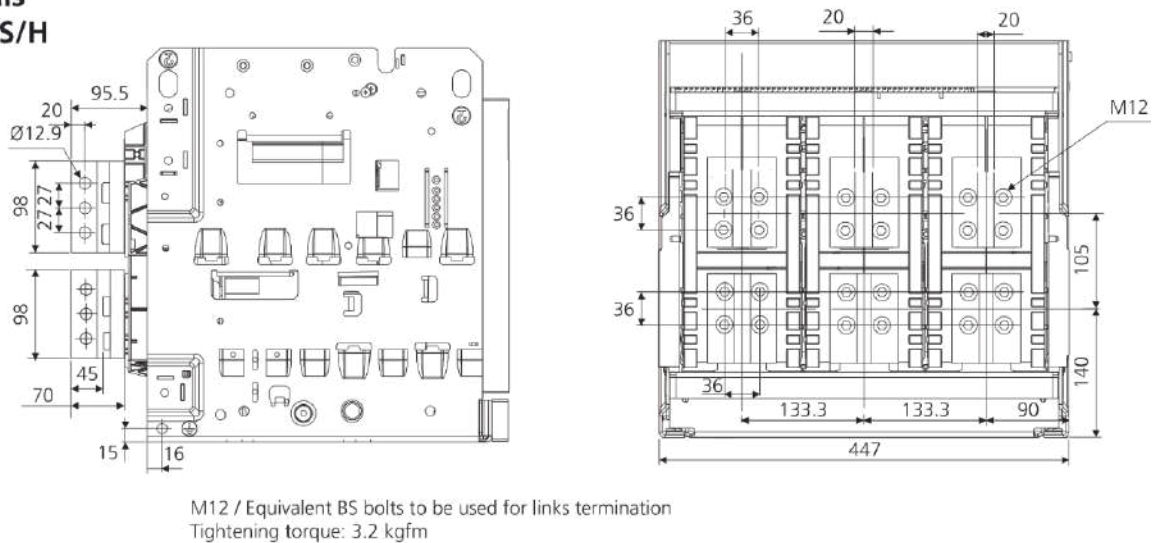

All Dimensions in mm

Delta ACB - Termination

Draw out Breakers

4000A S/H Fr.2-3P

Vertical Terminals

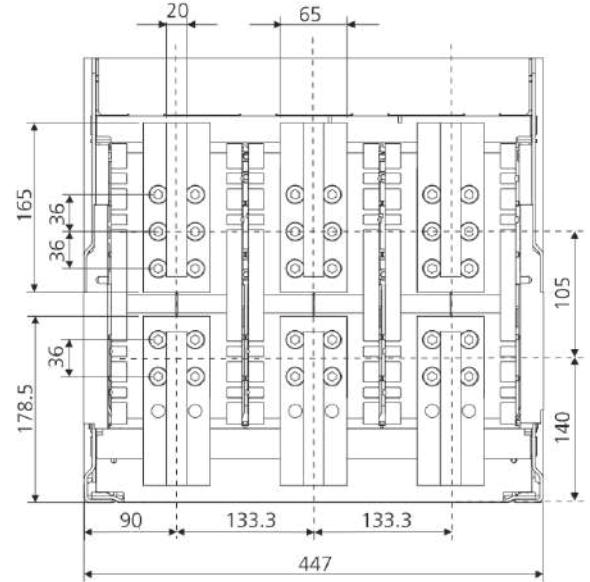
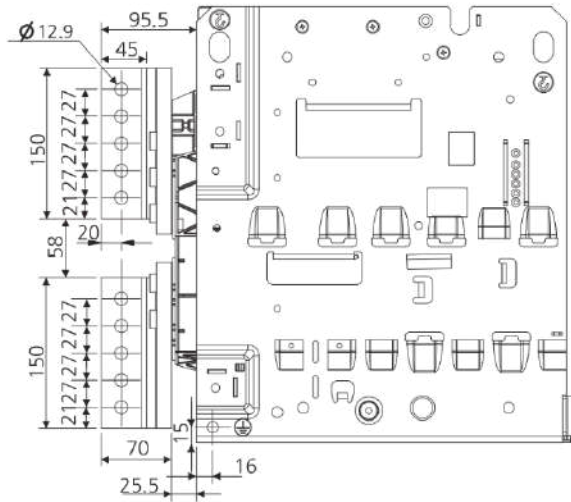

4000A S/H Fr.2-3P

Top Horizontal & Bottom Vertical Terminals

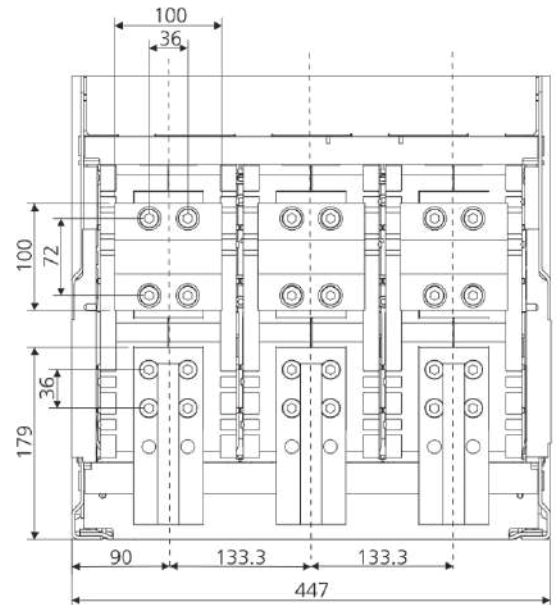
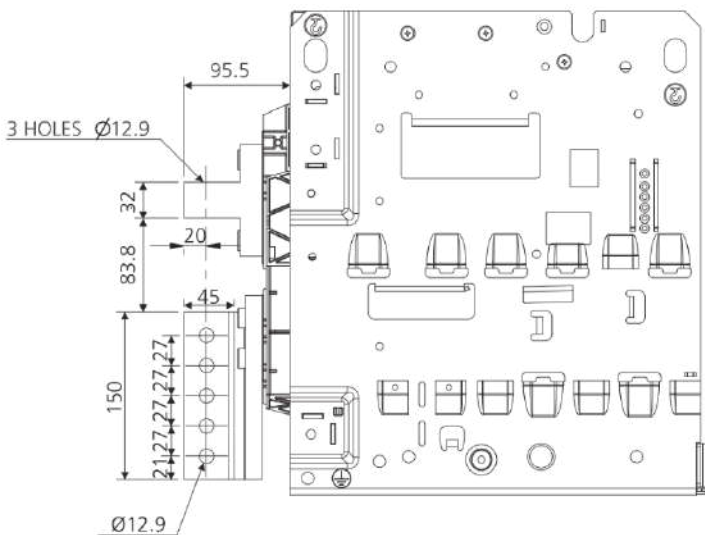

Horizontal: CL603160000

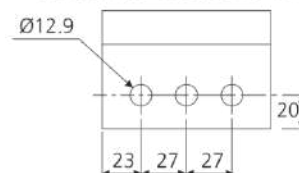

M12 / Equivalent BS bolts to be used for links termination.
Tightening torque: 3.2 kgfm

Delta ACB - Termination

Draw out Breakers

400A-3200A,N/S/H,Fr.2-4P (100% N)

Flat Terminals

400A-1600A,N/S/H

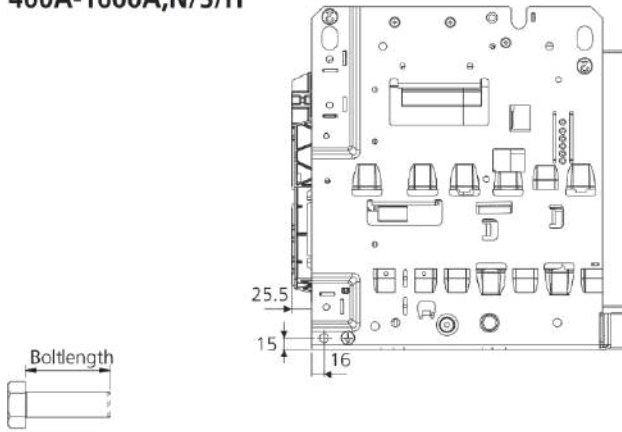

Bolt length for mounting link(s) on Flat Terminals to be cumulative link(s) thickness+20 min to 25 max

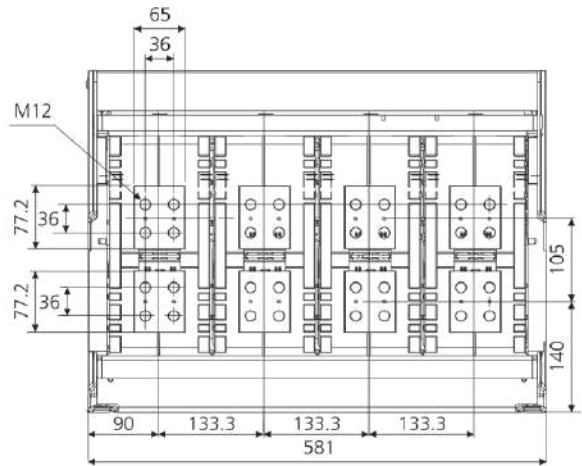

M12/ Equivalent BS bolts to be used for links termination. Tightening torque: 3.2 kgfm

Horizontal Terminals

400A-3200A N/S/H

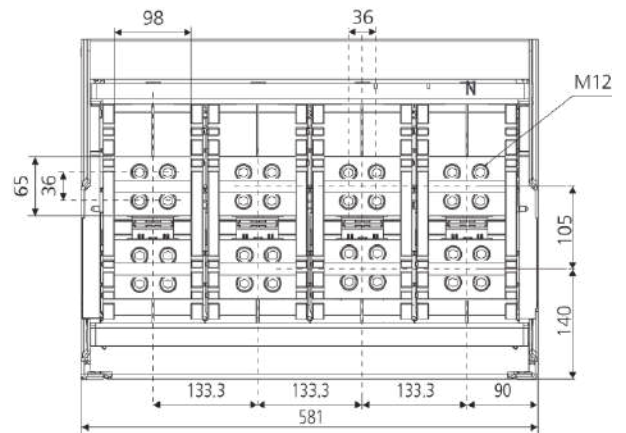
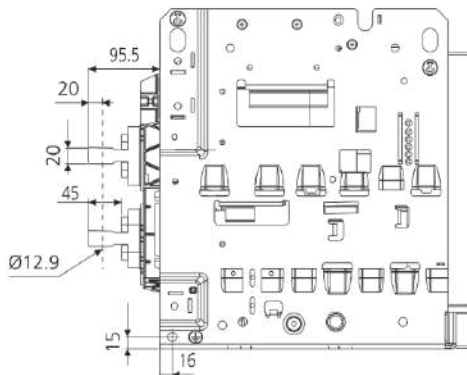

M12/ Equivalent BS bolts to be used for links termination. Tightening torque: 3.2 kgfm

Vertical Terminals

400A-3200A N/S/H

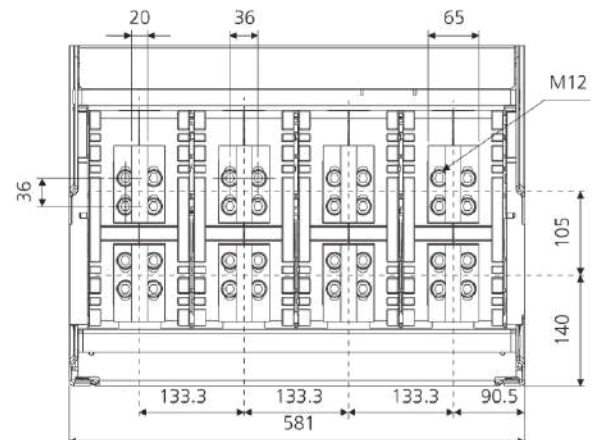
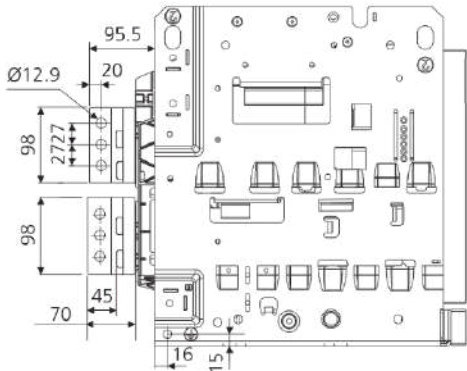

M12 / Equivalent BS bolts to be used for links termination. Tightening torque: 3.2kgfm

All Dimensions in mm

Delta ACB - Termination

Draw out Breakers

4000A S/H Fr.2-4P

Vertical Terminals

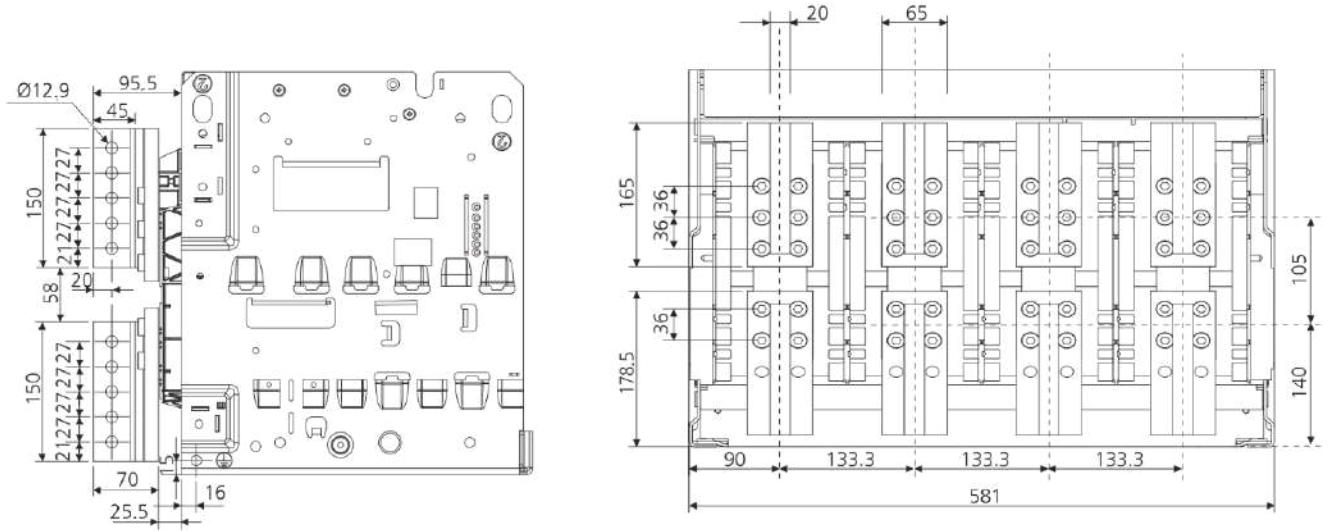

4000A S/H Fr.2-4P

Top Horizontal & Bottom Vertical Terminals

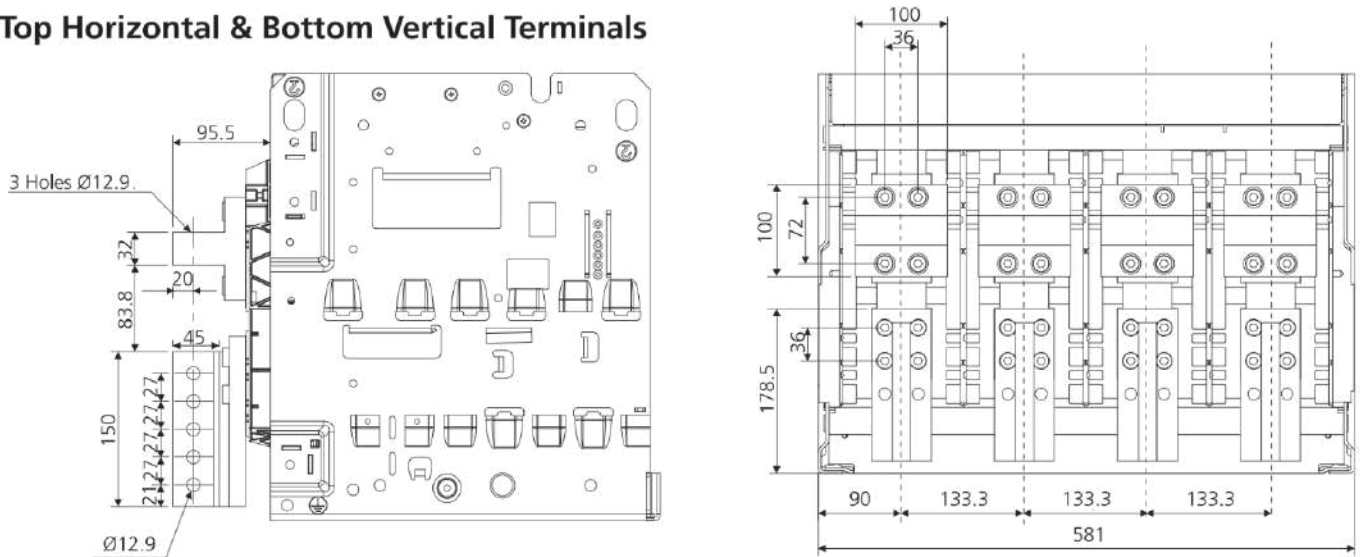

Horizontal: CL603160000

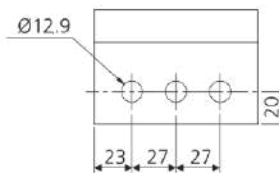

M12 / Equivalent BS bolts to be used for links termination.
Tightening torque: 3.2 kgfm

Delta ACB - Termination

Draw out Breakers

400-4000A H/V Fr.3 3P

Flat Terminals

400-1600A

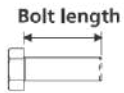

Bolt length for mounting link(s) on Flat Terminals to be cumulative link(s) thickness +20 min to 25 max

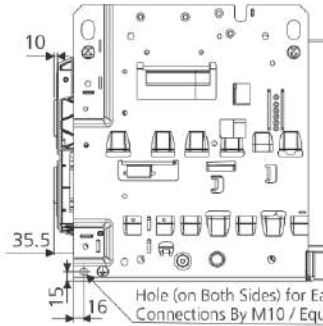

Hole (on Both Sides) for Earthing Connections By M10 / Equivalent Bs Bolt

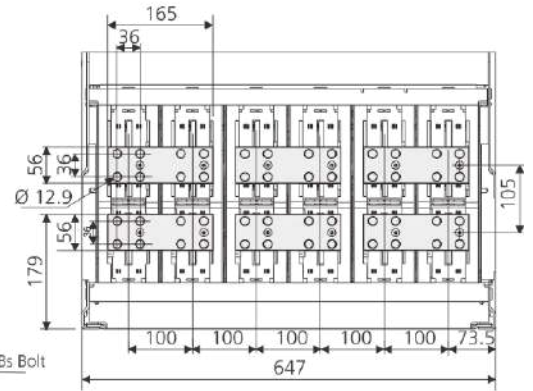

M12/ Equivalent BS bolts to be used for links termination. Tightening torque: 3.2 kgfm

Horizontal Terminals

400-4000A H/V

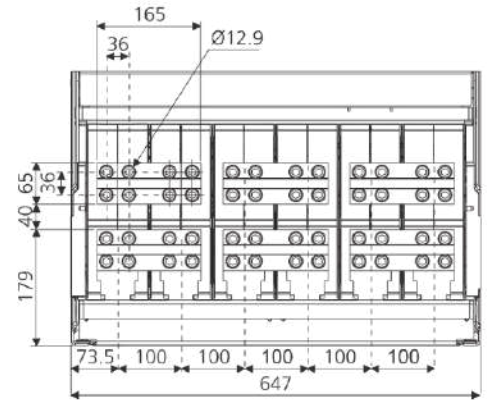
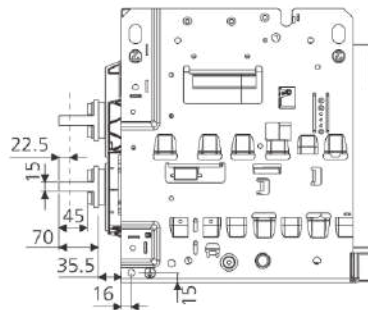
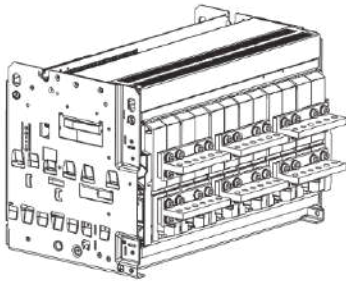

M12 / Equivalent BS bolts to be used for links termination. Tightening torque: 3.2 kgfm

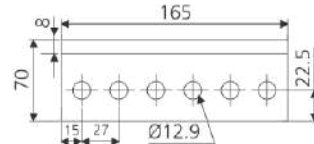

Vertical Terminals

400-4000A H/V

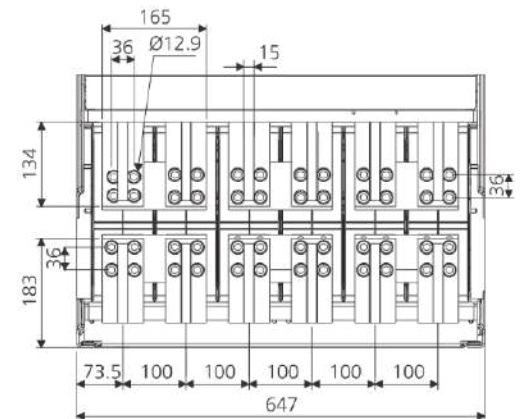
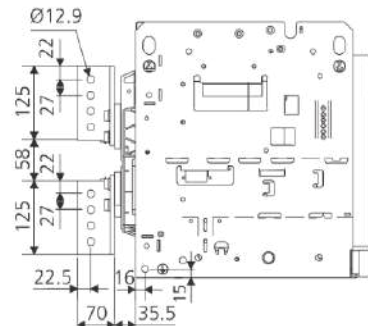
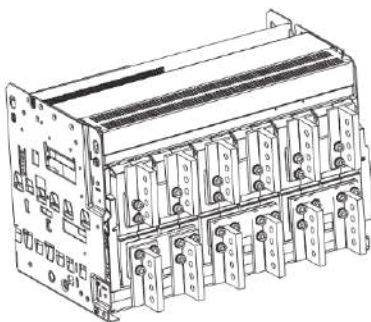

M12/Equivalent BS bolts to be used for links termination Tightening torque: 3.2 kgfm

All Dimensions in mm

Delta ACB - Termination

Draw out Breakers

5000-6300A H/V Fr.3 3P

Horizontal Terminals 5000A

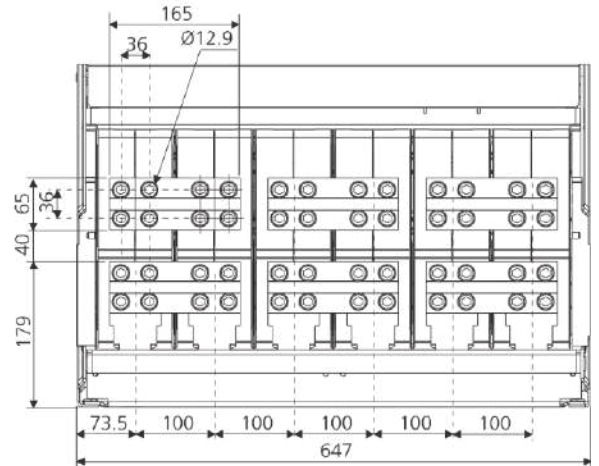
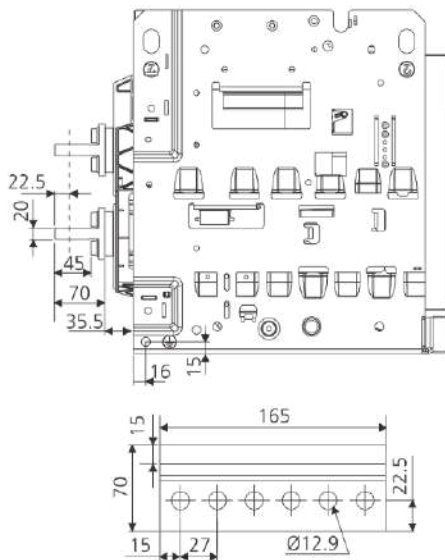
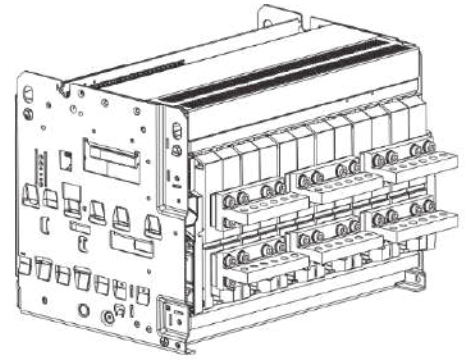

* H-H termination recommended for bus coupler only

M12/ Equivalent BS bolts to be used for links termination.
Tightening torque: 3.2 kgfm

Vertical Terminals 5000A

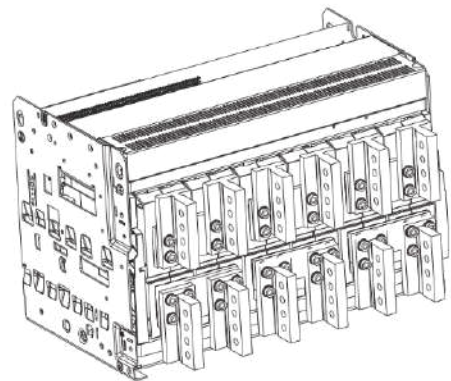

M12/ Equivalent BS bolts to be used for links termination.
Tightening torque: 3.2 kgfm

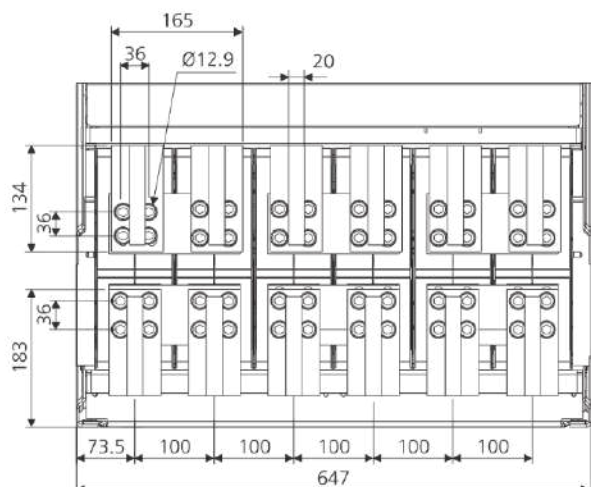
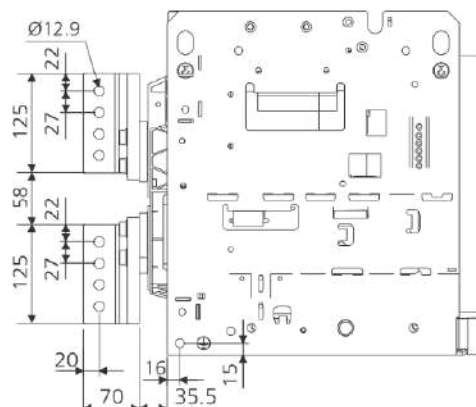

All Dimensions in mm

Delta ACB - Termination

Draw out Breakers

Vertical Terminals

6300A

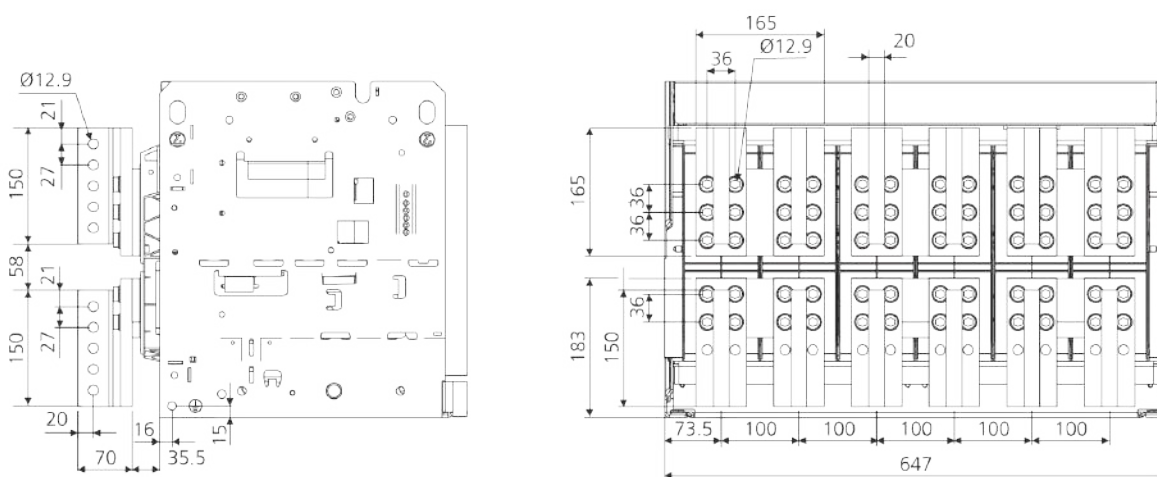
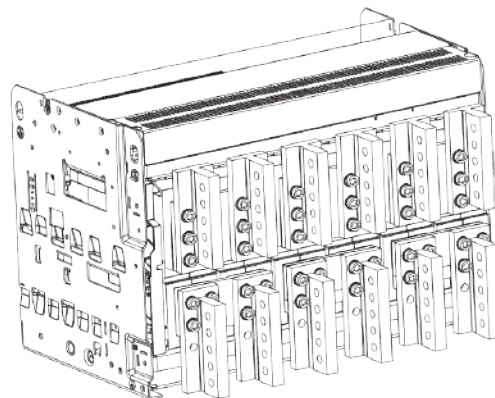

M12/ Equivalent BS bolts to be used for links termination.
Tightening torque: 3.2 kgfm

All Dimensions in mm

Delta ACB - Termination

Draw out Breakers

400A-5000A H/V Fr.3-4P (50% N)

Flat Terminals

400A-1600A H/V

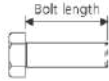

Bolt length for mounting link(s) on Flat Terminals to be cumulative link(s) thickness+20 min to 25 max

M12/ Equivalent BS bolts to be used for links termination.
Tightening torque: 3.2 kgfm

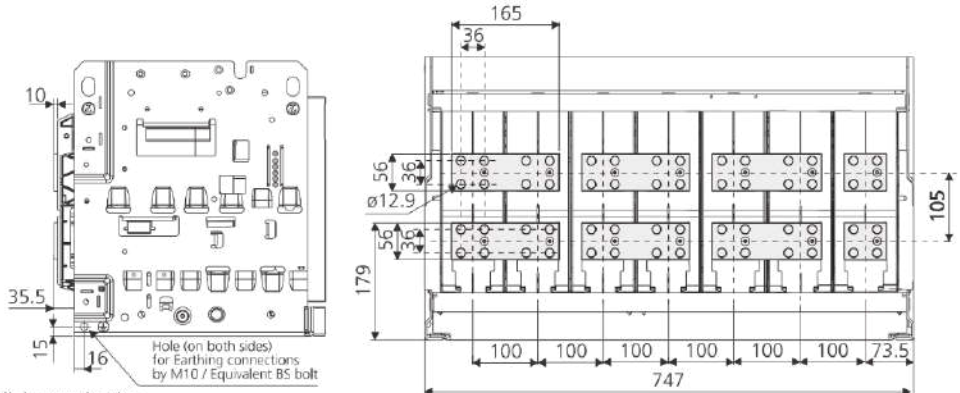

Horizontal Terminals

400A-4000A H/V

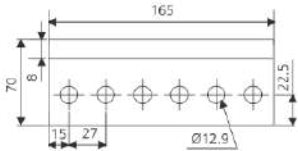

M12/ Equivalent BS bolts to be used for links termination.
Tightening torque: 3.2 kgfm

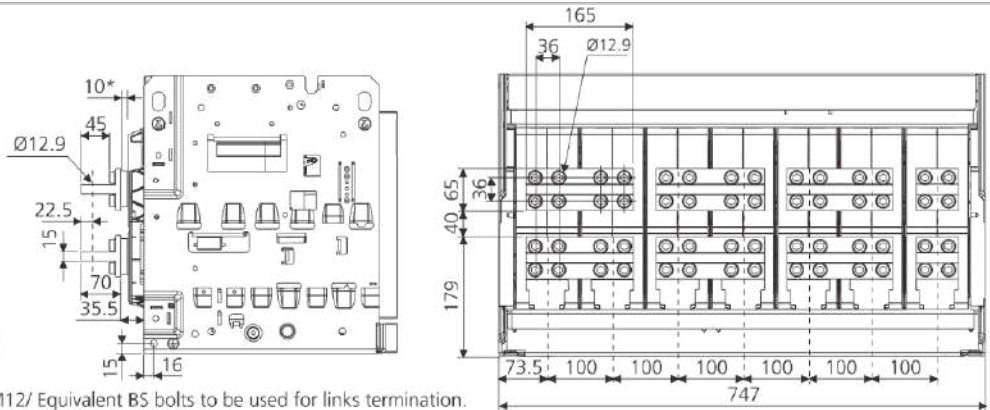

Vertical Terminals

400A-4000A H/V

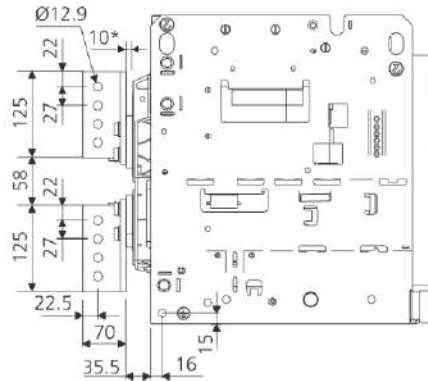

M12/ Equivalent BS bolts to be used for links termination.
Tightening torque: 3.2 kgfm

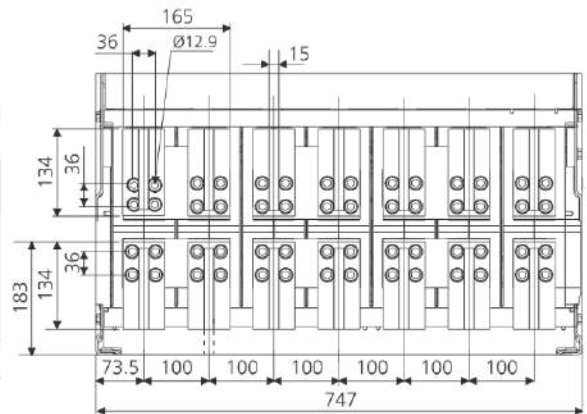

Vertical Terminals

5000A H/V

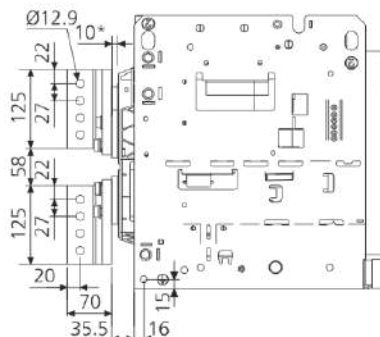

M12/Equivalent BS bolts to be used for link termination
Tightening torque: 3.2 kgfm

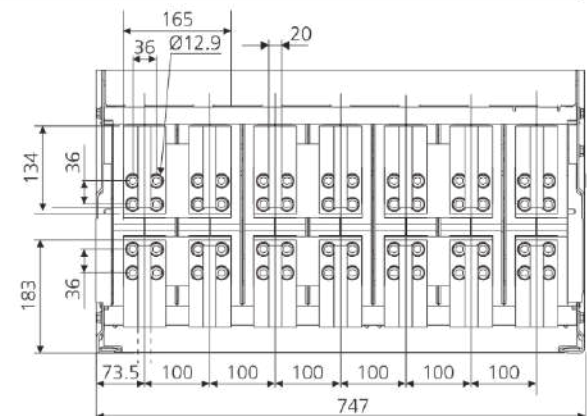

All Dimensions in mm

* 10 mm Terminal Height difference due to equalizer for Neutral

Delta ACB - Termination

Draw out Breakers

400-4000A H/V Fr.3 4P (100% N)

Flat Terminals 400-1600A

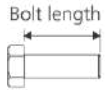

Bolt length for mounting link(s) on Flat Terminals to be cumulative link(s) thickness +20 min to 25 max

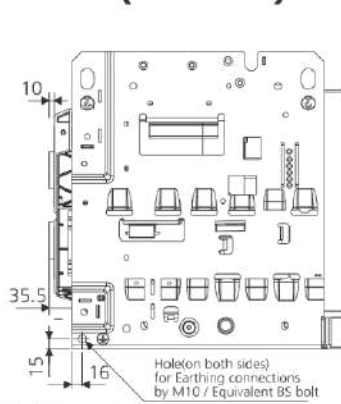

M12/ Equivalent BS bolts to be used for links termination.
Tightening torque: 3.2 kgfm

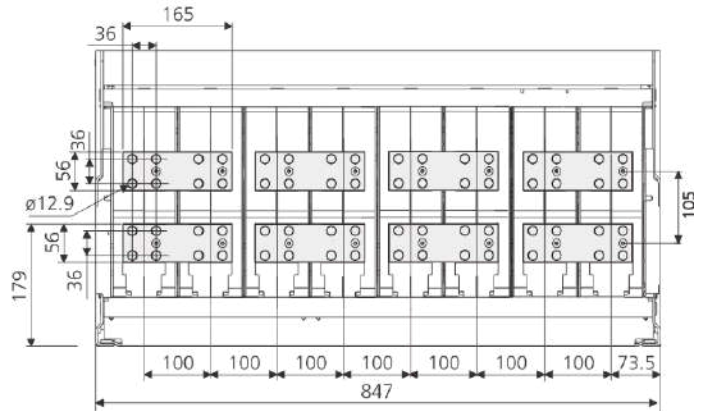

Horizontal Terminals 400-4000A

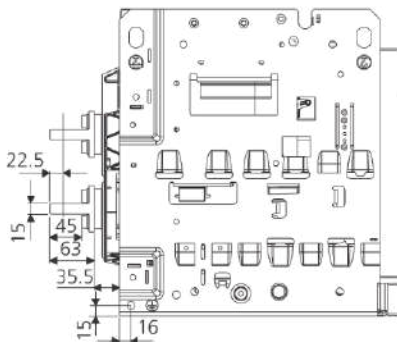
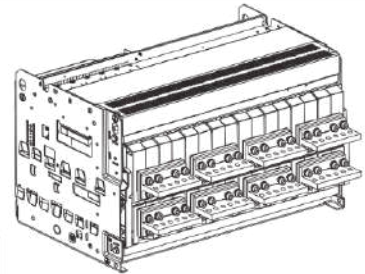
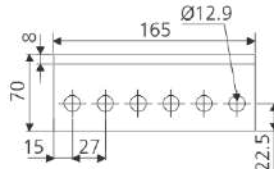

M12/ Equivalent BS bolts to be used for links termination.
Tightening torque: 3.2 kgfm

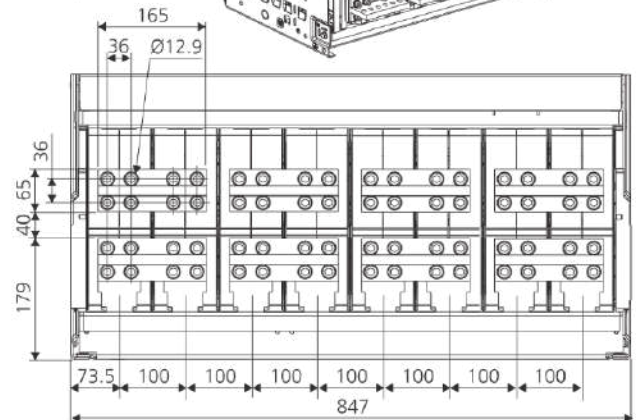

Vertical Terminals 400-4000A

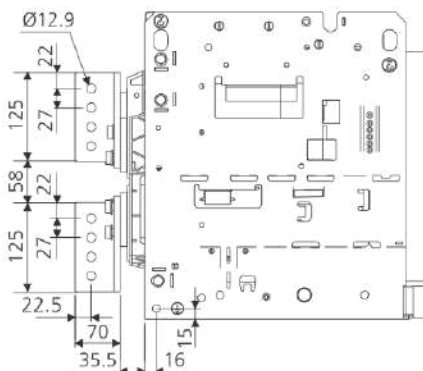
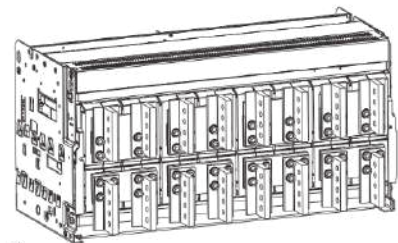

M12/Equivalent BS bolts to be used for links termination Tightening torque: 3.2 kgfm

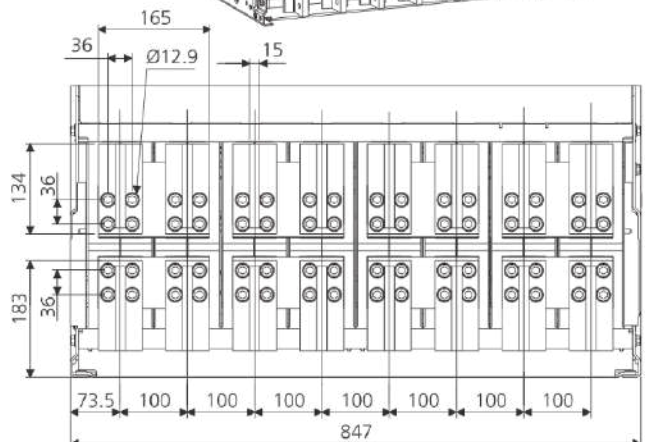

All Dimensions in mm

Delta ACB - Termination

Draw out Breakers

400-6300A H/V Fr.3 4P (100% N)

Horizontal Terminals 5000A

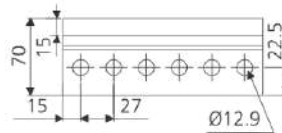
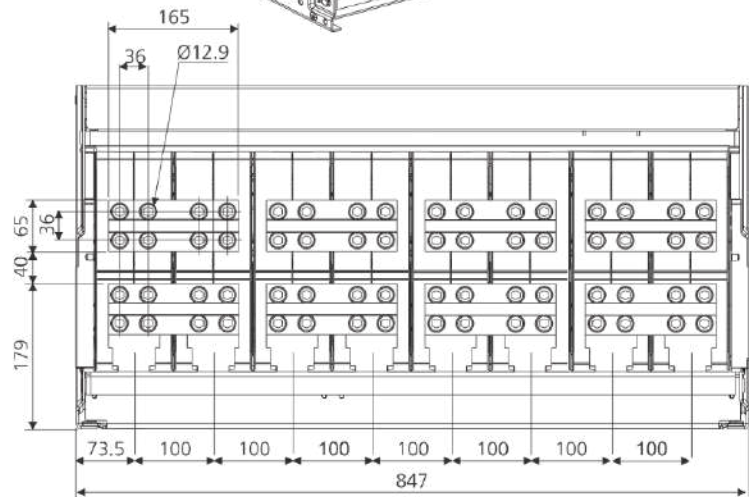
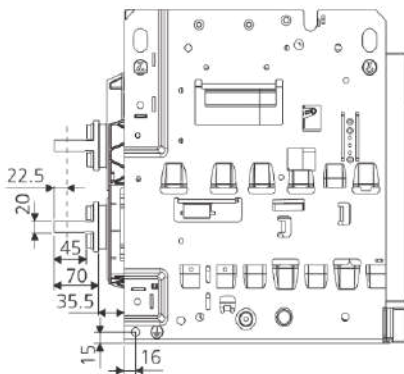
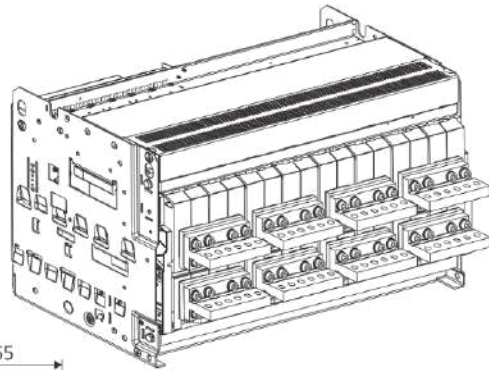

M12/ Equivalent BS bolts to be used for links termination.
Tightening torque: 3.2 kgfm

Vertical Terminals 5000A

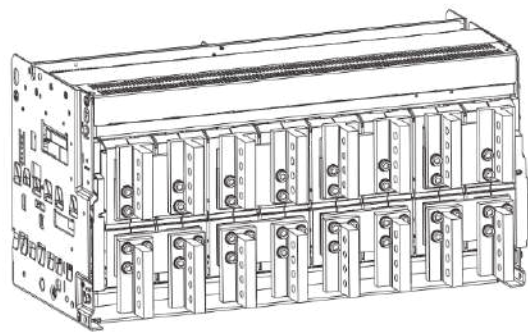

M12/ Equivalent BS bolts to be used for links termination.
Tightening torque: 3.2 kgfm

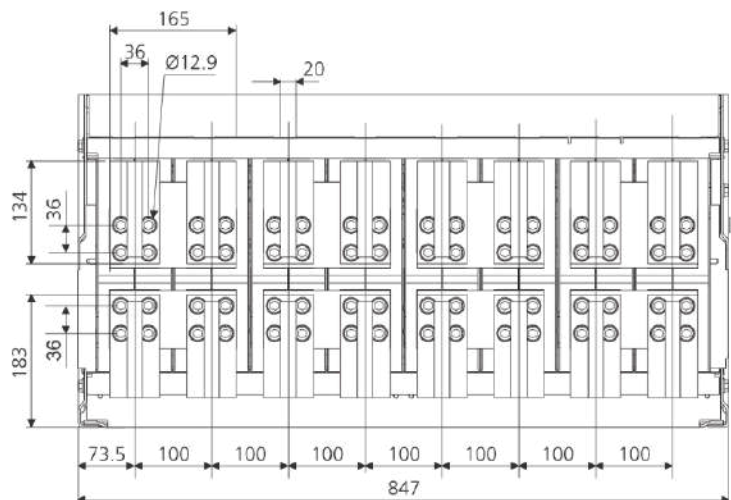
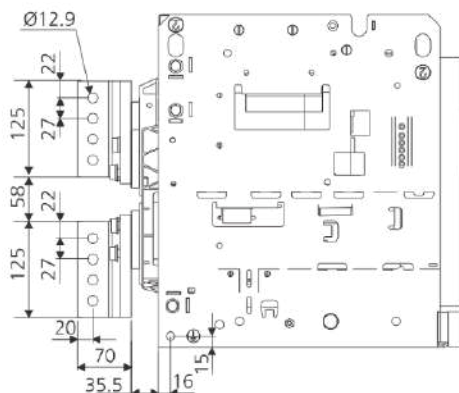

All Dimensions in mm

Delta ACB - Termination

Draw out Breakers

Vertical Terminals 6300A

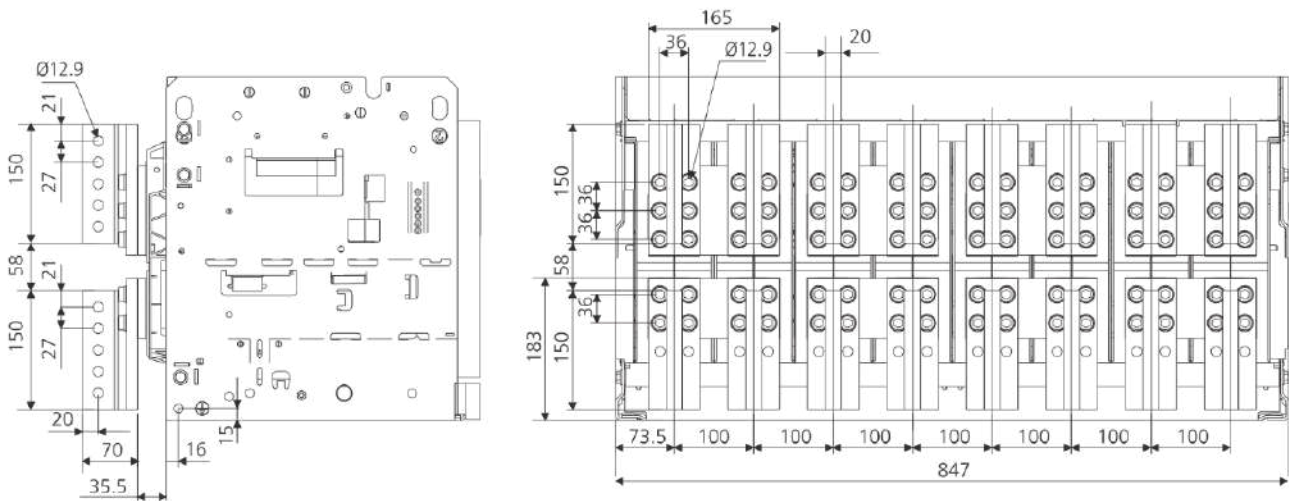
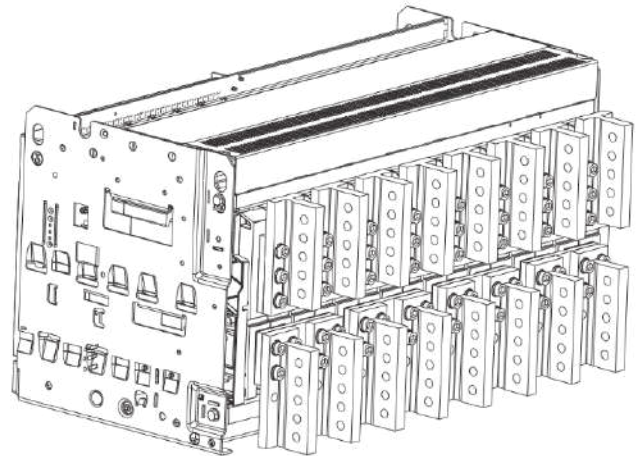

M12/ Equivalent BS bolts to be used for links termination.
Tightening torque: 3.2 kgfm

400A-2000A H/V,Fr.3-4P (200%N)*

Flat Terminals 400A-1600A H/V

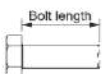
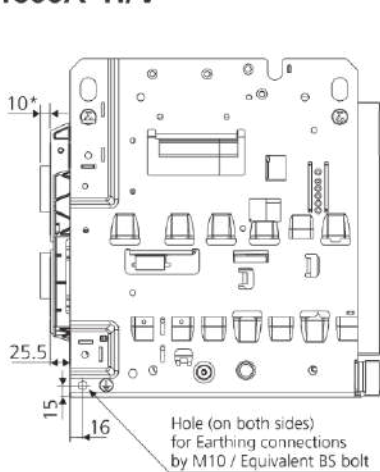

Bolt length for mounting link(s) on Flat Terminals to be cumulative link(s) thickness+20 min to 25 max

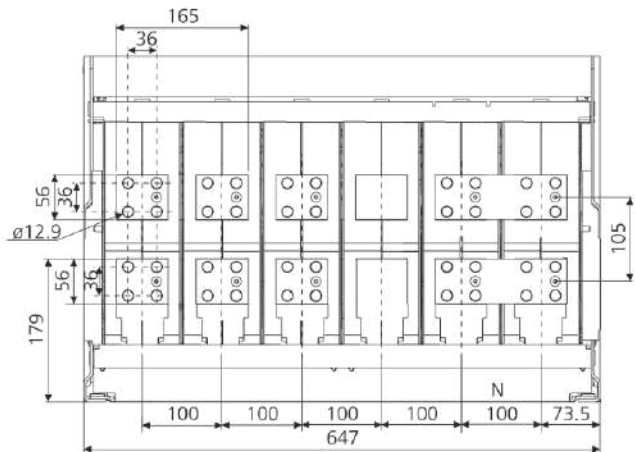

*10 mm Terminal height difference due to equalizer for Neutral.

M 12/ Equivalent BS bolts to be used for links termination.
Tightening torque: 3.2 kgfm

*Option for 400-1250A Fr.1-4P 200%N and 400-1600A Fr.2-4P 200%N Also available.

All Dimensions in mm

Delta ACB - Termination

Draw out Breakers

Horizontal Terminals 400A-2000A H/V

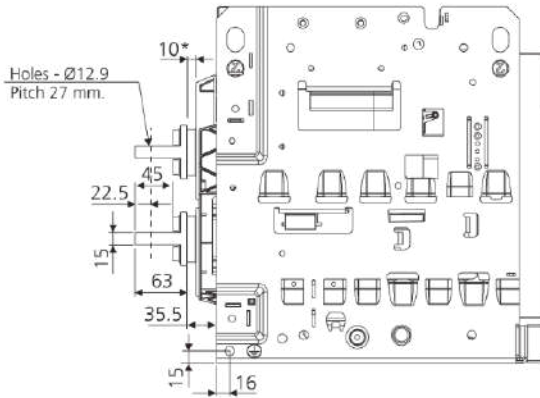

M12 / Equivalent BS bolts to be used for links termination.
Tightening torque: 3.2 kgfm

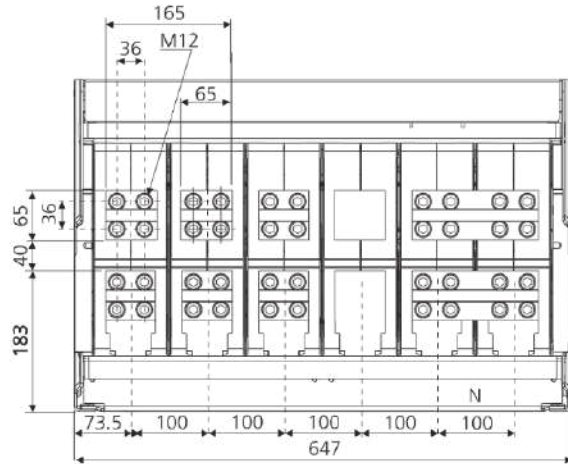

*10 mm Terminal height difference due to equalizer for Neutral.

Vertical Terminals 400A-2000A H/V

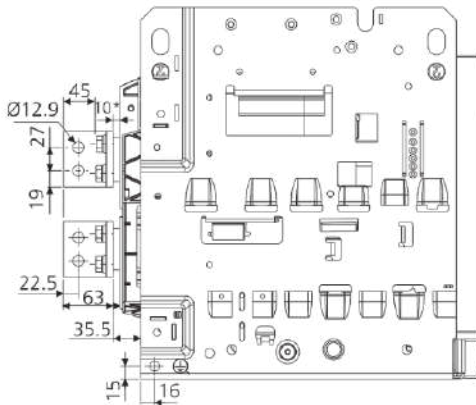

M12 / Equivalent BS bolts to be used for links termination.
Tightening torque: 3.2 kgfm

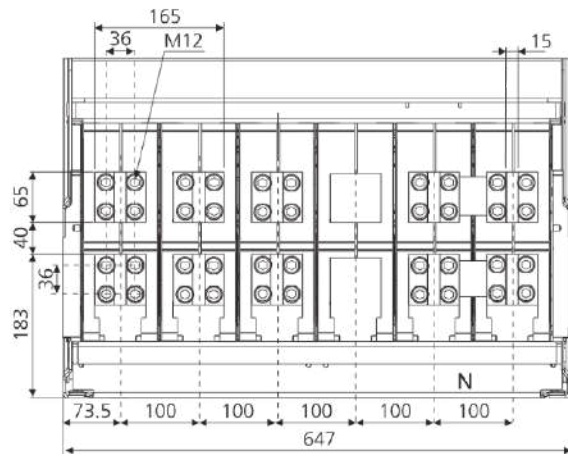

*10 mm Terminal height difference due to equalizer for Neutral.

Vertical Terminals FOR 2500A H/V, Fr.3-4P(200%N)

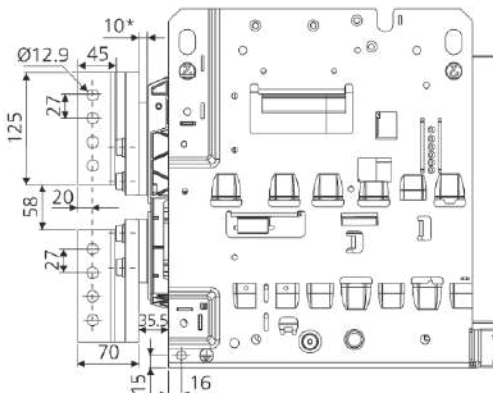

M12 / Equivalent BS bolts to be used for links termination.
Tightening torque: 3.2 kgfm

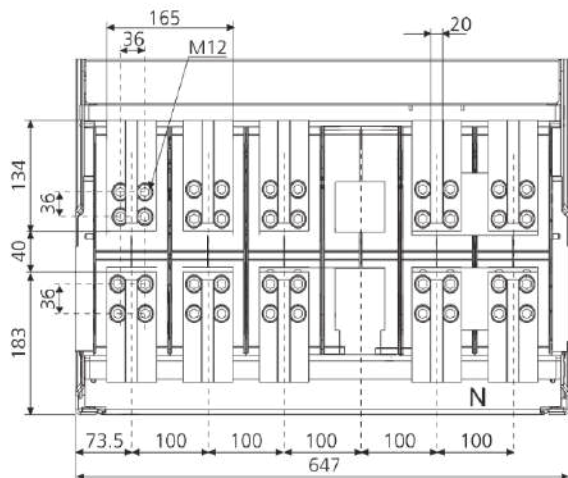

*10 mm Terminal height difference due to equalizer for Neutral.

All Dimensions in mm

Delta ACB - Mounting Details

400-1600A N & 400-2500A S/H Fr.1 3P

Fixed Circuit Breaker

| Frame 1 | A |
|--------------|-----|
| 400-2000 N/S | 326 |
| 2500 S | 324 |
| 400-2500 H | 324 |

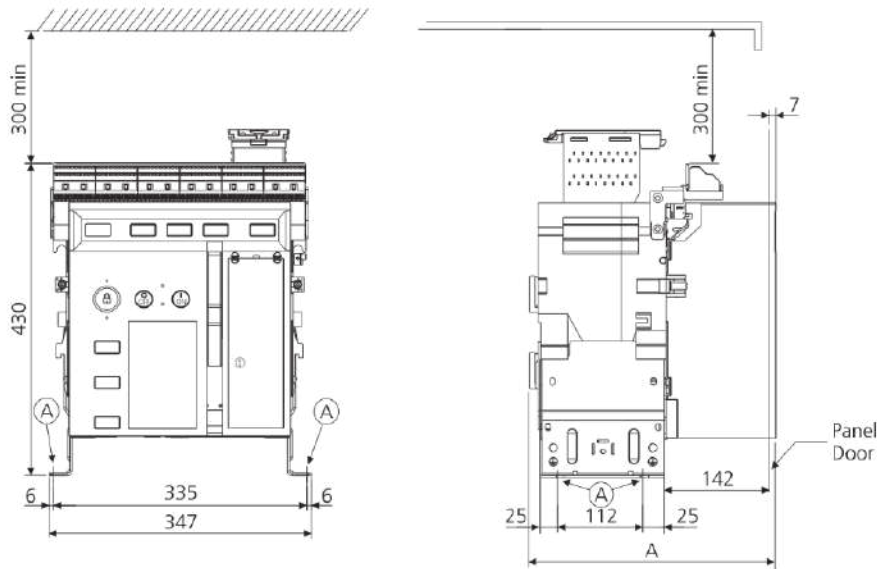

Draw-out Circuit Breaker

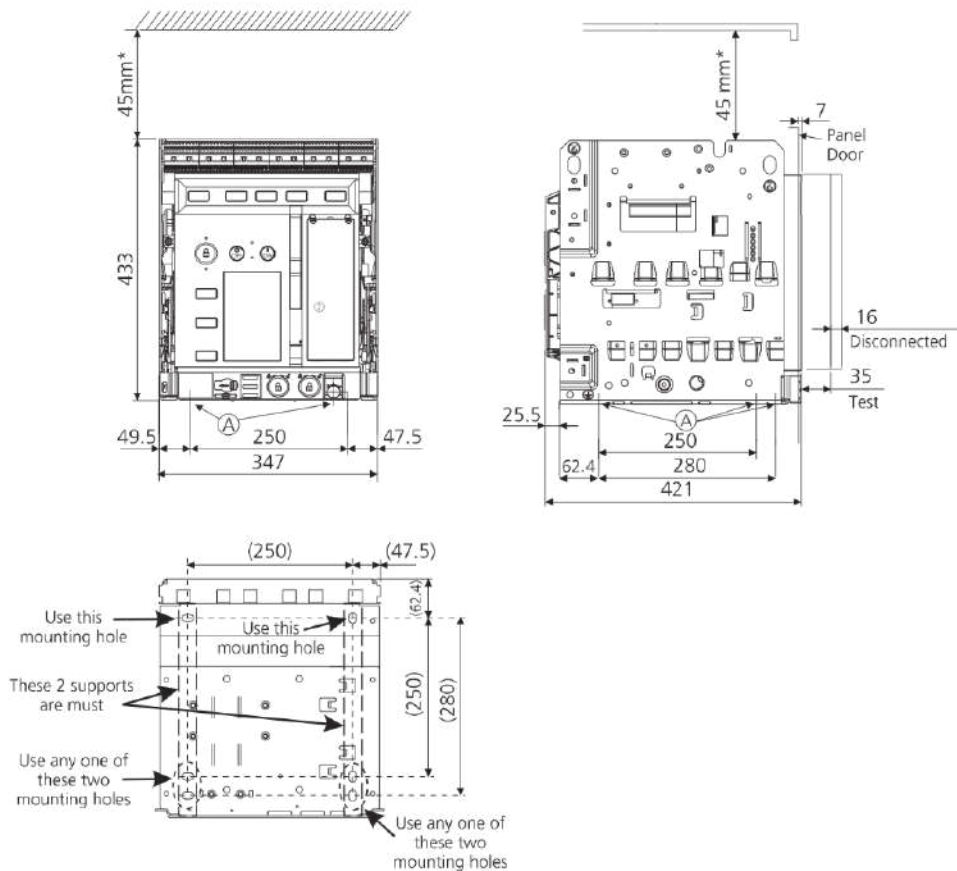

All Dimensions in mm

Ⓐ Mounting holes suitable for M10 / Equivalent BS bolt

* In case of Temperature Module mounted on the Cradle this dimension should be 70mm.

All Dimensions in mm

Delta ACB - Mounting Details

400-1600A N & 400-2500A S/H Fr.1 4P (100% N)

Fixed Circuit Breaker

| Frame 1 | A |
|--------------|-----|
| 400-2000 N/S | 326 |
| 2500 S | 324 |
| 400-2500 H | 324 |

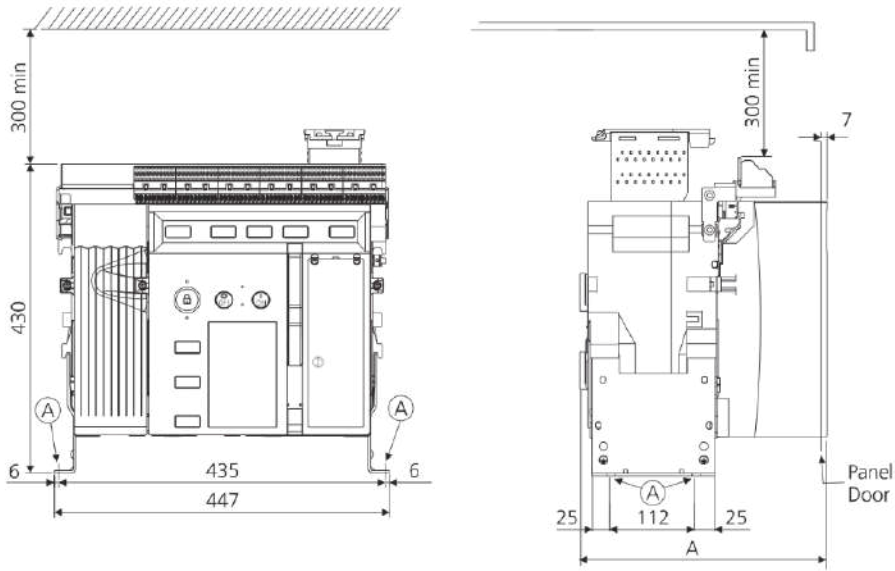

Draw-out Circuit Breaker

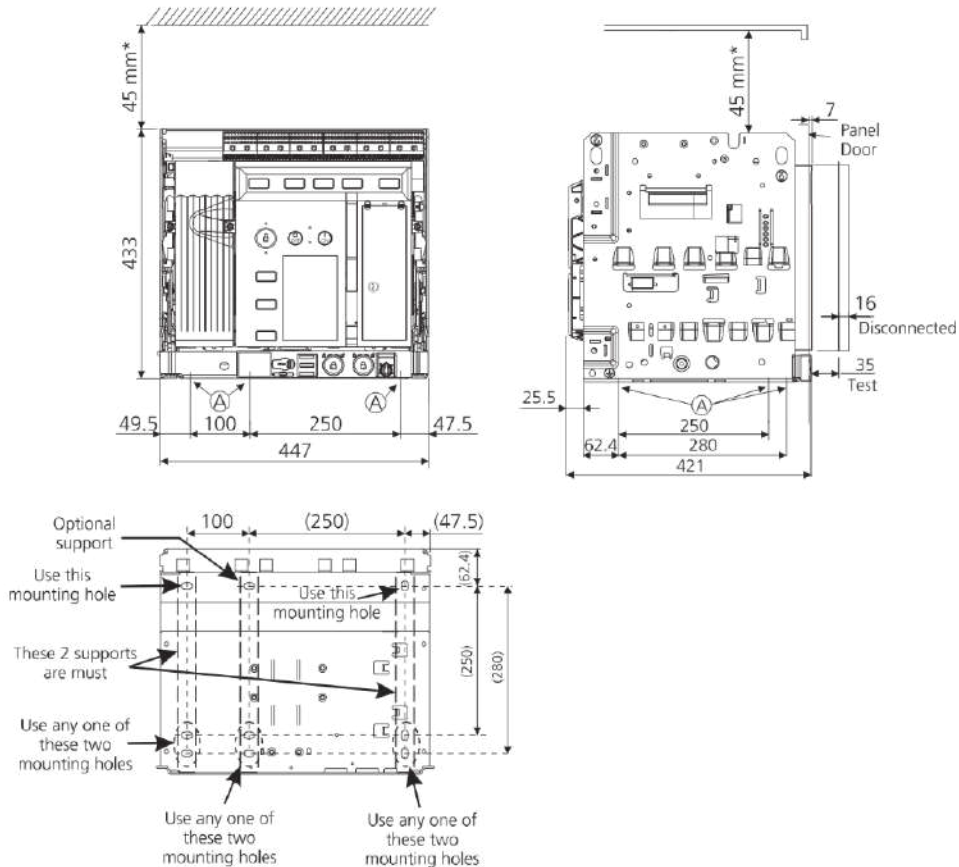

Details of 4P (200%) on request

All Dimensions in mm

Ⓐ Mounting holes suitable for M10 / Equivalent BS bolt

* In case of Temperature Module mounted on the Cradle this dimension should be 70mm.

All Dimensions in mm

Delta ACB - Mounting Details

400-3200A N & 400-4000A S/H Fr.2 3P

Fixed Circuit Breaker

| Frame 2 | A |
|--------------|-----|
| 400-2500 N/S | 326 |
| 3200 N/S | 324 |
| 400-3200 H | 324 |
| 4000 S/H | 324 |

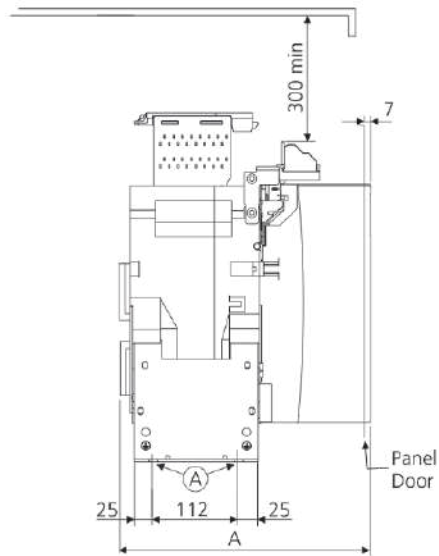
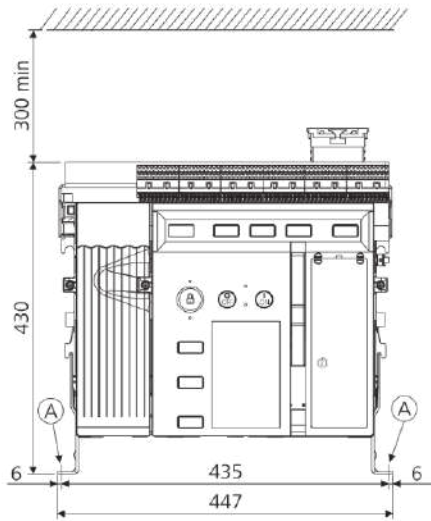

Draw-out Circuit Breaker

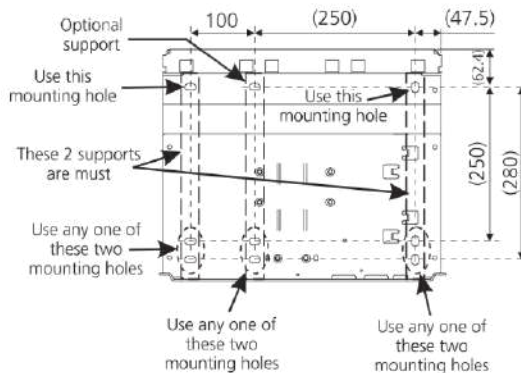
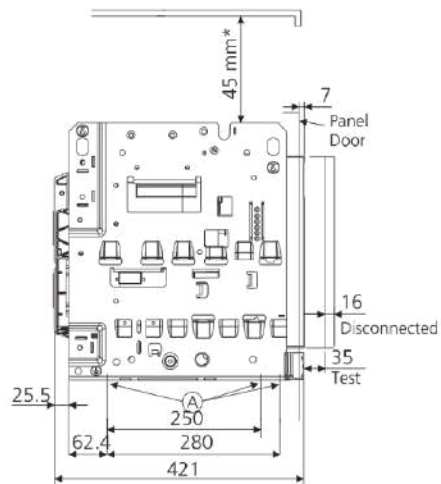
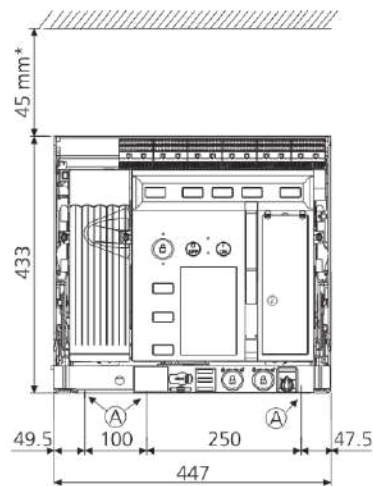

All Dimensions in mm

Ⓐ Mounting holes suitable for M10 / Equivalent BS bolt

* In case of Temperature Module mounted on the Cradle this dimension should be 70mm.

All Dimensions in mm

Delta ACB - Mounting Details

400-3200A N & 400-4000A S/H Fr.2 4P (100% N)

Fixed Circuit Breaker

| Frame 2 | A |
|--------------|-----|
| 400-2500 N/S | 326 |
| 3200 N/S | 324 |
| 400-3200 H | 324 |
| 4000 S/H | 324 |

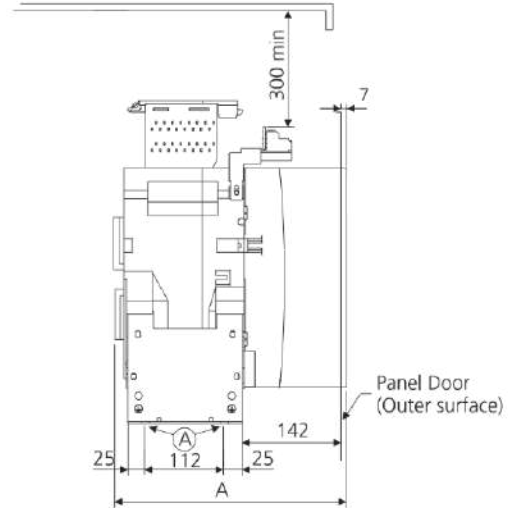
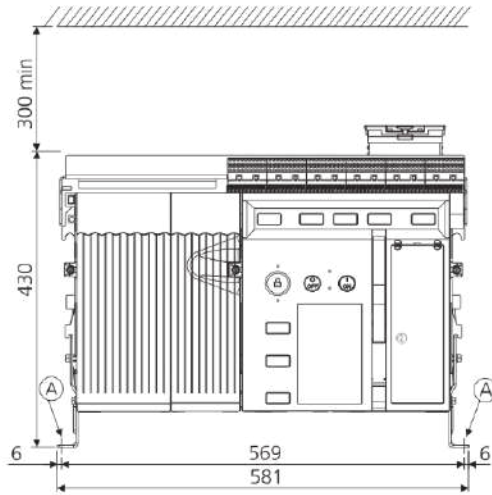

Draw-out Circuit Breaker

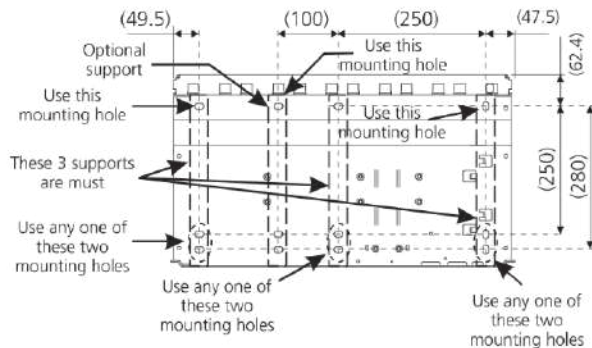
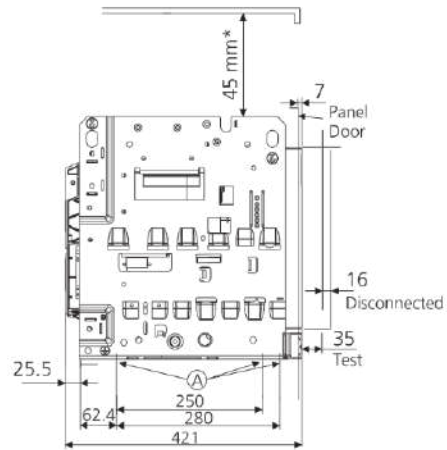
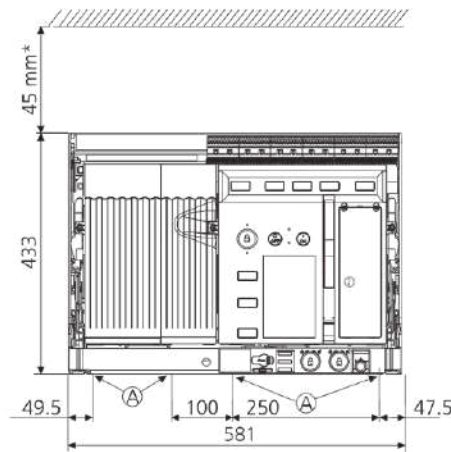

Details of 4P (200% N) on request

All Dimensions in mm

Ⓐ Mounting holes suitable for M10 / Equivalent BS bolt

* In case of Temperature Module mounted on the Cradle this dimension should be 70mm.

All Dimensions in mm

Delta ACB - Mounting Details

400-6300A H/V Fr.3 3P

Fixed Circuit Breaker

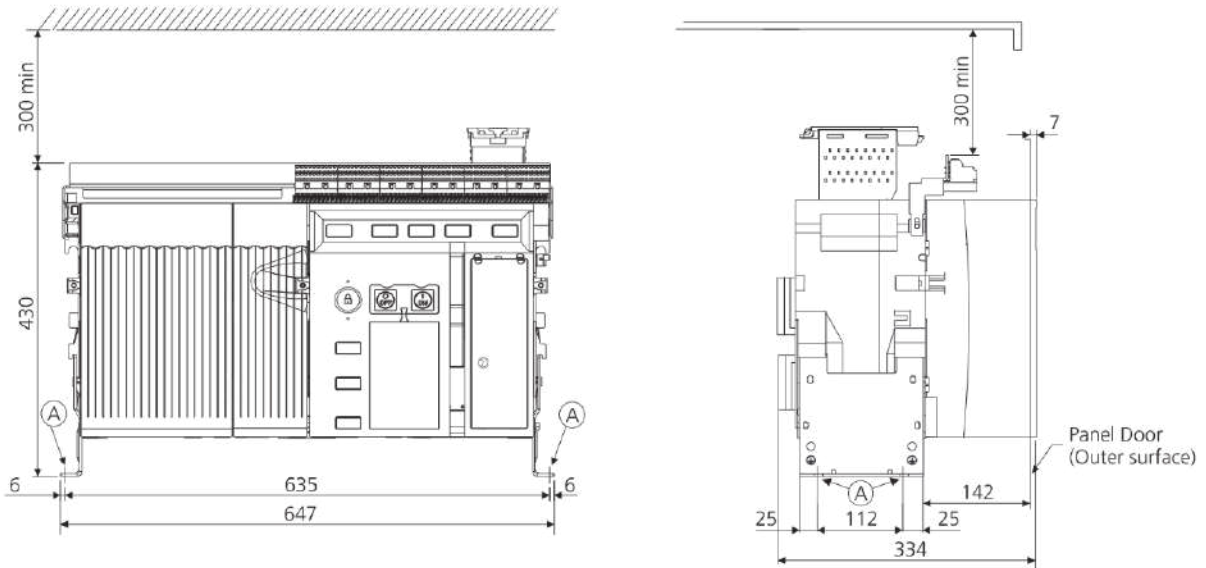

Draw-out Circuit Breaker

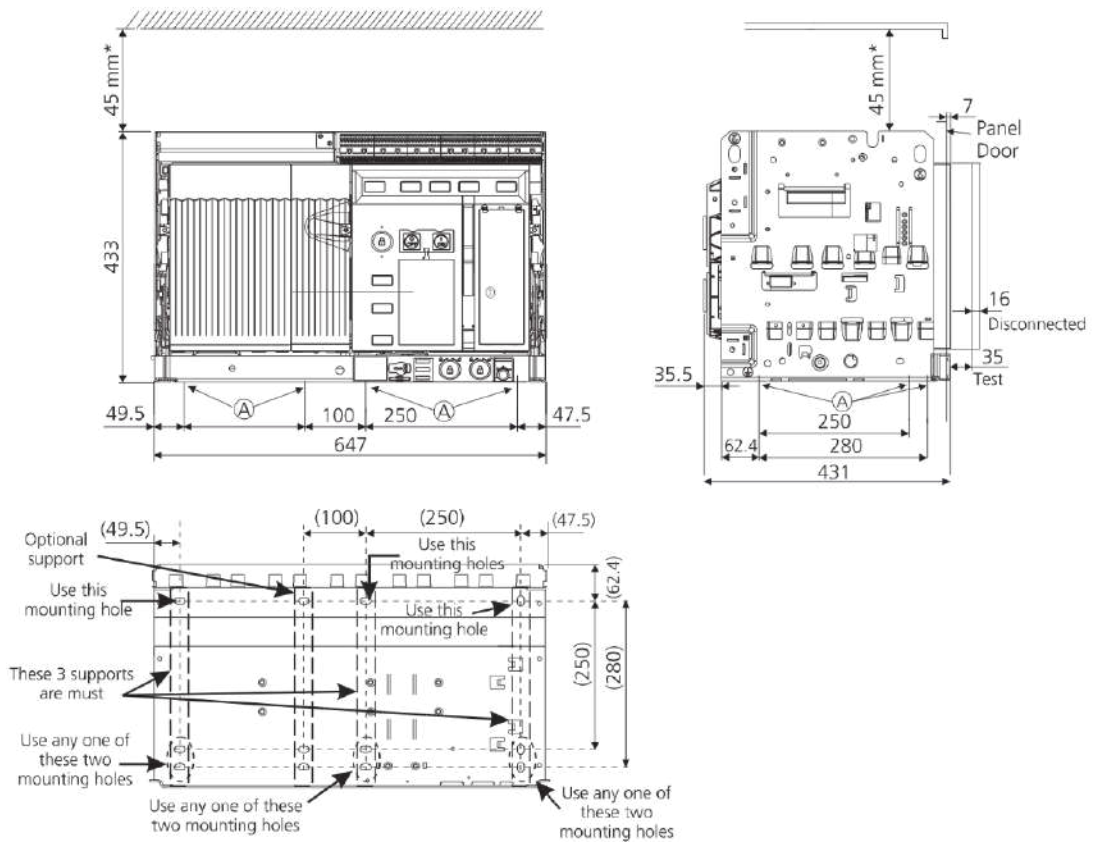

All Dimensions in mm

Ⓐ Mounting holes suitable for M10 / Equivalent BS bolt

* In case of Temperature Module mounted on the Cradle this dimension should be 70mm.

All Dimensions in mm

Delta ACB - Mounting Details

400-6300A H/V Fr.3 4P (100% N)

Fixed Circuit Breaker

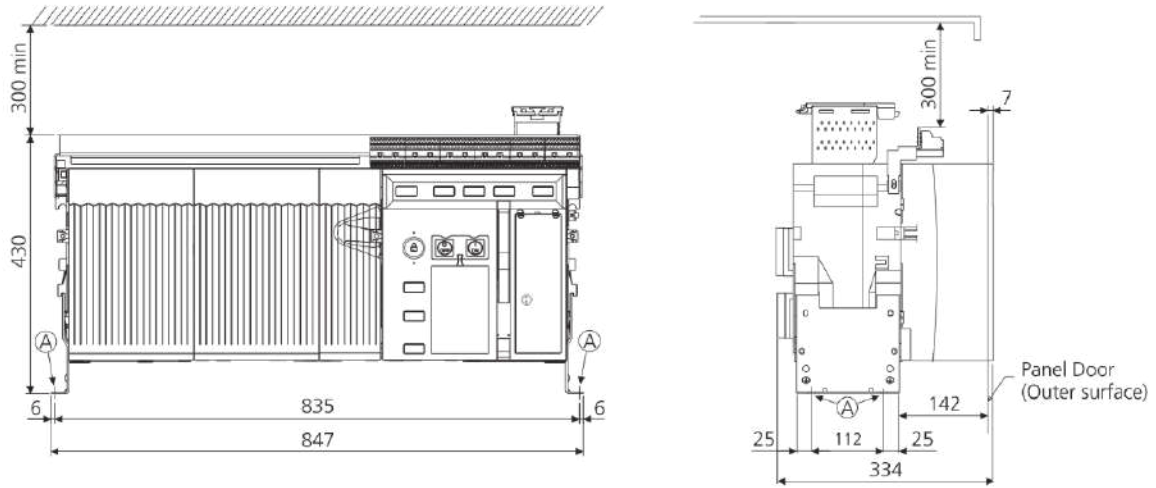

Draw-out Circuit Breaker

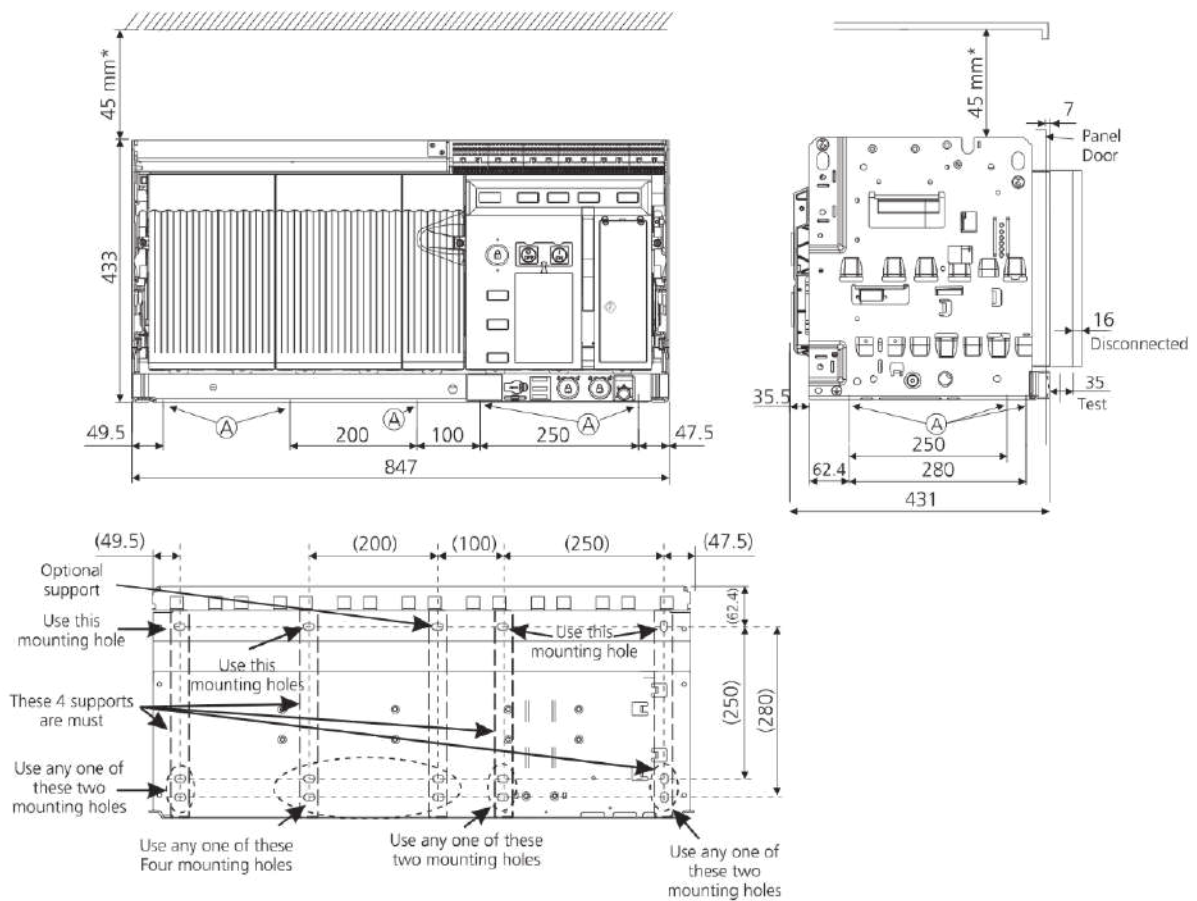

Details of 4P (50% N) on request

All Dimensions in mm

Ⓐ Mounting holes suitable for M10 / Equivalent BS bolt

* In case of Temperature Module mounted on the Cradle this dimension should be 70mm.

All Dimensions in mm

Helping you
simplify energy
and process
management.

Explore solutions >

ELMEASURE[®]
Possibilities...Infinite

©2023 Elmeasure. All Rights Reserved.
Elmeasure brand name and the logo are
registered trademarks of Elmeasure.
This document is protected by copyright laws.
Reproduction and distribution of the same
without a prior written permission is prohibited.

Changes to the products or the information
contained in this document. Product photos
are for representation purpose do not warrant
a specific feature or functionality. Their use in
whatever form is subject to our prior approval.

Registered Address:
Elmeasure India Private Limited,
#47P, KIADB, Huvinayakanahalli,
Jala Hobli, Bagalur - 562149
Bangalore, Karnataka, India.

Visit: www.elmeasure.com

For latest updates, follow us:

